



audio-technica



Wireless Systems



Wireless Systems

WIRELESS INTRODUCTION

WIRELESS ATW-C	4
WIRELESS MANAGER - FREQUENCY	6
WIRELESS SERIES OVERVIEW	7

WIRELESS SYSTEMS

5000 Series	8
3000 Series	10
2000 Series	14
AT-One	16
System 10 / System 10 PRO	18
Antennas	22
Accessories	24
cH/cW Mic Summary	25-27

WIRELESS APPLICATIONS

Application 1 - Dual-channel wireless system	28
Application 2 - Single-channel wireless system covering two zones	29
Application 3 - Multiple zones wireless system	30
Application 4 - Four-channel wireless system	32
Application 5 - Multi-channel wireless system for install	34
Application 6 - 16-channel wireless system using ATW-DA49a	36
Application 7 - 16-channel wireless system using daisy chain	38
Application 8 - 64-channel wireless system / 256-channel wireless system	40
Radio Equipment Directive (RED) - Restrictions	42-43

/ Interchangeable
Microphone
Capsules (IMC)



/ Handheld
Transmitter Body
ATW-T5202



/ Handheld
Transmitter Body
ATW-T3202



/ Cardioid
Condenser
ATW-C5400

/ Cardioid
Condenser
ATW-C3300

/ Hypercardioid
Dynamic
ATW-C6100

/ Cardioid
Dynamic
ATW-C4100

/ Cardioid
Condenser
ATW-C710

/ Cardioid
Dynamic
ATW-C510

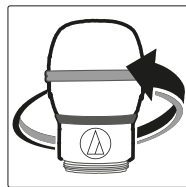

Interchangeable Microphone Capsules
compatible with last generation 3000 and
5000 Series wireless handheld transmitters

All interchangeable microphone capsules can be used with **ATW-T5202**
and **ATW-T3202** handheld transmitters. Its industry-standard thread
allows use with other compatible handheld transmitters.

Condenser microphones capsules **ATW-C5400** and **ATW-C3300**
an heritage from the world acclaimed Studio microphones **AT4050** and **AT4033**.



/ Interchangeable Cardioid
Condenser Microphone Capsule
ATW-C5400



Same sound
characteristics as the
renowned **AT4050**
studio microphone
offering extreme clarity
and realism.



/ Interchangeable Cardioid
Condenser Microphone Capsule
ATW-C3300



Same element as the
classic **AT4033a** studio
microphone offering
extreme clarity
and realism.

Clean, Crisp and Accurate

Transparent uppers/mids and rich low-end qualities are
combined with advanced acoustic engineering
for extensive performance abilities and a clean, crisp
and accurate sound reproduction, even at high SPLs.

Warm and Flattering Sound

The AT4033a produces a warm and flattering sound that
brings the versatility of a dynamic microphone,
as well as the transparency and detail of a high-end
capacitor model for a vintage effect.



Everything under control

The Wireless Manager software supports the setup, control, and monitoring of compatible Audio-Technica wireless devices. The software allows you to determine device settings, make and coordinate frequency plans while offline, and configure import settings whilst connected to wireless systems via network connection. When linked to a compatible receiver, you can scan the RF environment, monitor connected devices, and view the system log.

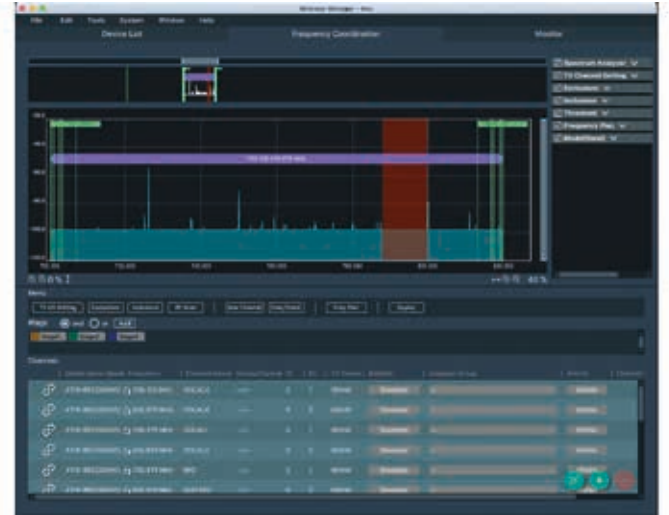
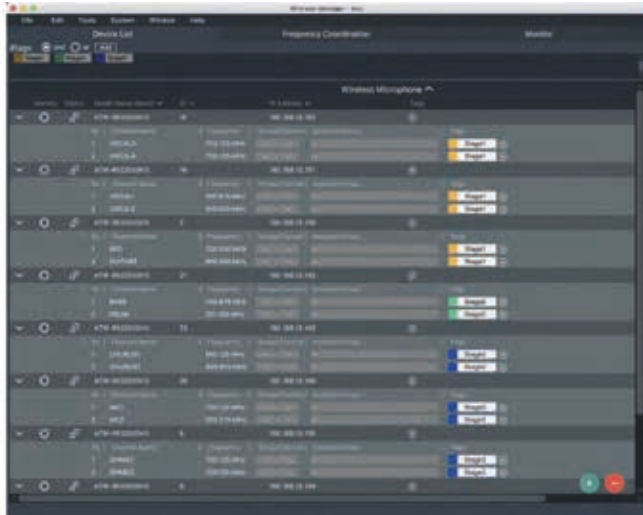

WIRELESS SYSTEMS / FREQUENCY

Audio-Technica - Frequency bands versus wireless series

Frequency from > to	470	478	486	494	502	510	518	526	534	542	550	558	566	574	582	590	598	606	614	622	630	638	646	654	662	670	678	686	694	702	710	718	726	734	742	750	758	766	774	782	790	798	806	814	822	830	838	846	854	862	870	878	886	894	902	910	918	926	934	942	950	958	966	974	982	990	998	1006	1014	1022	1030	1038	1046	1054	1062	1070	1078	1086	1094	1102	1110	1118	1126	1134	1142	1150	1158	1166	1174	1182	1190	1198	1206	1214	1222	1230	1238	1246	1254	1262	1270	1278	1286	1294	1302	1310	1318	1326	1334	1342	1350	1358	1366	1374	1382	1390	1398	1406	1414	1422	1430	1438	1446	1454	1462	1470	1478	1486	1494	1502	1510	1518	1526	1534	1542	1550	1558	1566	1574	1582	1590	1598	1606	1614	1622	1630	1638	1646	1654	1662	1670	1678	1686	1694	1702	1710	1718	1726	1734	1742	1750	1758	1766	1774	1782	1790	1798	1806	1814	1822	1830	1838	1846	1854	1862	1870	1878	1886	1894	1902	1910	1918	1926	1934	1942	1950	1958	1966	1974	1982	1990	1998	2006	2014	2022	2030	2038	2046	2054	2062	2070	2078	2086	2094	2102	2110	2118	2126	2134	2142	2150	2158	2166	2174	2182	2190	2198	2206	2214	2222	2230	2238	2246	2254	2262	2270	2278	2286	2294	2302	2310	2318	2326	2334	2342	2350	2358	2366	2374	2382	2390	2398	2406	2414	2422	2430	2438	2446	2454	2462	2470	2478	2486	2494	2502	2510	2518	2526	2534	2542	2550	2558	2566	2574	2582	2590	2598	2606	2614	2622	2630	2638	2646	2654	2662	2670	2678	2686	2694	2702	2710	2718	2726	2734	2742	2750	2758	2766	2774	2782	2790	2798	2806	2814	2822	2830	2838	2846	2854	2862	2870	2878	2886	2894	2902	2910	2918	2926	2934	2942	2950	2958	2966	2974	2982	2990	2998	3006	3014	3022	3030	3038	3046	3054	3062	3070	3078	3086	3094	3102	3110	3118	3126	3134	3142	3150	3158	3166	3174	3182	3190	3198	3206	3214	3222	3230	3238	3246	3254	3262	3270	3278	3286	3294	3302	3310	3318	3326	3334	3342	3350	3358	3366	3374	3382	3390	3398	3406	3414	3422	3430	3438	3446	3454	3462	3470	3478	3486	3494	3502	3510	3518	3526	3534	3542	3550	3558	3566	3574	3582	3590	3598	3606	3614	3622	3630	3638	3646	3654	3662	3670	3678	3686	3694	3702	3710	3718	3726	3734	3742	3750	3758	3766	3774	3782	3790	3798	3806	3814	3822	3830	3838	3846	3854	3862	3870	3878	3886	3894	3902	3910	3918	3926	3934	3942	3950	3958	3966	3974	3982	3990	3998	4006	4014	4022	4030	4038	4046	4054	4062	4070	4078	4086	4094	4102	4110	4118	4126	4134	4142	4150	4158	4166	4174	4182	4190	4198	4206	4214	4222	4230	4238	4246	4254	4262	4270	4278	4286	4294	4302	4310	4318	4326	4334	4342	4350	4358	4366	4374	4382	4390	4398	4406	4414	4422	4430	4438	4446	4454	4462	4470	4478	4486	4494	4502	4510	4518	4526	4534	4542	4550	4558	4566	4574	4582	4590	4598	4606	4614	4622	4630	4638	4646	4654	4662	4670	4678	4686	4694	4702	4710	4718	4726	4734	4742	4750	4758	4766	4774	4782	4790	4798	4806	4814	4822	4830	4838	4846	4854	4862	4870	4878	4886	4894	4902	4910	4918	4926	4934	4942	4950	4958	4966	4974	4982	4990	4998	5006	5014	5022	5030	5038	5046	5054	5062	5070	5078	5086	5094	5102	5110	5118	5126	5134	5142	5150	5158	5166	5174	5182	5190	5198	5206	5214	5222	5230	5238	5246	5254	5262	5270	5278	5286	5294	5302	5310	5318	5326	5334	5342	5350	5358	5366	5374	5382	5390	5398	5406	5414	5422	5430	5438	5446	5454	5462	5470	5478	5486	5494	5502	5510	5518	5526	5534	5542	5550	5558	5566	5574	5582	5590	5598	5606	5614	5622	5630	5638	5646	5654	5662	5670	5678	5686	5694	5702	5710	5718	5726	5734	5742	5750	5758	5766	5774	5782	5790	5798	5806	5814	5822	5830	5838	5846	5854	5862	5870	5878	5886	5894	5902	5910	5918	5926	5934	5942	5950	5958	5966	5974	5982	5990	5998	6006	6014	6022	6030	6038	6046	6054	6062	6070	6078	6086	6094	6102	6110	6118	6126	6134	6142	6150	6158	6166	6174	6182	6190	6198	6206	6214	6222	6230	6238	6246	6254	6262	6270	6278	6286	6294	6302	6310	6318	6326	6334	6342	6350	6358	6366	6374	6382	6390	6398	6406	6414	6422	6430	6438	6446	6454	6462	6470	6478	6486	6494	6502	6510	6518	6526	6534	6542	6550	6558	6566	6574	6582	6590	6598	6606	6614	6622	6630	6638	6646	6654	6662	6670	6678	6686	6694	6702	6710	6718	6726	6734	6742	6750	6758	6766	6774	6782	6790	6798	6806	6814	6822	6830	6838	6846	6854	6862	6870	6878	6886	6894	6902	6910	6918	6926	6934	6942	6950	6958	6966	6974	6982	6990	6998	7006	7014	7022	7030	7038	7046	7054	7062	7070	7078	7086	7094	7102	7110	7118	7126	7134	7142	7150	7158	7166	7174	7182	7190	7198	7206	7214	7222	7230	7238	7246	7254	7262	7270	7278	7286	7294	7302	7310	7318	7326	7334	7342	7350	7358	7366	7374	7382	7390	7398	7406	7414	7422	7430	7438	7446	7454	7462	7470	7478	7486	7494	7502	7510	7518	7526	7534	7542	7550	7558	7566	7574	7582	7590	7598	7606	7614	7622	7630	7638	7646	7654	7662	7670	7678	7686	7694	7702	7710	7718	7726	7734	7742	7750	7758	7766	7774	7782	7790	7798	7806	7814	7822	7830	7838	7846	7854	7862	7870	7878	7886	7894	7902	7910	7918	7926	7934	7942	7950	7958	7966	7974	7982	7990	7998	8006	8014	8022	8030	8038	8046	8054	8062	8070	8078	8086	8094	8102	8110	8118	8126	8134	8142	8150	8158	8166	8174	8182	8190	8198	8206	8214	8222	8230	8238	8246	8254	8262	8270	8278	8286	8294	8302	8310	8318	8326	8334	8342	8350	8358	8366	8374	8382	8390	8398	8406	8414	8422	8430	8438	8446	8454	8462	8470	8478	8486	8494	8502	8510	8518	8526	8534	8542	8550	8558	8566	8574	8582	8590	8598	8606	8614	8622	8630	8638	8646	8654	8662	8670	8678	8686	8694	8702	8710	8718	8726	8734	8742	8750	8758	8766	8774	8782	8790	8798	8806	8814	8822	8830	8838	8846	8854	8862	8870	8878	8886	8894	8902	8910	8918	8926	8934	8942	8950	8958	8966	8974	8982	8990	8998	9006	9014	9022	9030	9038	9046	9054	9062	9070	9078	9086	9094	9102	9110	9118	9126	9134	9142	9150	9158	9166	9174	9182	9190	9198	9206	9214	9222	9230	9238	9246	9254	9262	9270	9278	9286	9294	9302	9310	9318	9326	9334	9342	9350	9358	9366	9374	9382	9390	9398	9406	9414	9422	9430	9438	9446	9454	9462	9470	9478	9486	9494	9502	9510	9518	9526	9534	9542	9550	9558	9566	9574	9582	9590	9598	9606	9614	9622	9630	9638	9646	9654	9662	9670	9678	9686	9694	9702	9710	9718	9726	9734	9742	9750	9758	9766	9774	9782	9790	9798	9806	9814	9822	9830	9838	9846	9854	9862	9870	9878	9886	9894	9902	9910	9918	9926	9934	9942	9950	9958	9966	9974	9982	9990	9998	10006	10014	10022	10030	10038	10046	10054	10062	10070	10078	10086	10094	10102	10110	10118	10126	10134	10142	10150	10158	10166	10174	10182	10190	10198	10206	10214	10222	10230	10238	10246	10254	10262	10270	10278	10286	10294	10302	10310	10318	10326	10334	10342	10350	10358	10366	10374	10382	10390	10398	10406	10414	10422	10430	10438	10446	10454	10462	10470	10478	10486	10494	10502	10510	10518	10526	10534	10542	10550	10558	10566	10574	10582	10590	10598	10606	10614	10622	10630	10638	10646	10654	10662	10670	10678	10686	10694	10702	10710	10718	10726	10734	10742	10750	10758	10766	10774	10782	10790	10798	10806	10814	10822	10830	10838	10846	10854	10862	10870	10878	10886	10894	10902	10910	10918	10926	10934	10942	10950	10958	10966	10974	10982	10990	10998	11006	11014
---------------------	-----	-----	-----	-----	-----	-----	-----	-----	-----	-----	-----	-----	-----	-----	-----	-----	-----	-----	-----	-----	-----	-----	-----	-----	-----	-----	-----	-----	-----	-----	-----	-----	-----	-----	-----	-----	-----	-----	-----	-----	-----	-----	-----	-----	-----	-----	-----	-----	-----	-----	-----	-----	-----	-----	-----	-----	-----	-----	-----	-----	-----	-----	-----	-----	-----	-----	-----	------	------	------	------	------	------	------	------	------	------	------	------	------	------	------	------	------	------	------	------	------	------	------	------	------	------	------	------	------	------	------	------	------	------	------	------	------	------	------	------	------	------	------	------	------	------	------	------	------	------	------	------	------	------	------	------	------	------	------	------	------	------	------	------	------	------	------	------	------	------	------	------	------	------	------	------	------	------	------	------	------	------	------	------	------	------	------	------	------	------	------	------	------	------	------	------	------	------	------	------	------	------	------	------	------	------	------	------	------	------	------	------	------	------	------	------	------	------	------	------	------	------	------	------	------	------	------	------	------	------	------	------	------	------	------	------	------	------	------	------	------	------	------	------	------	------	------	------	------	------	------	------	------	------	------	------	------	------	------	------	------	------	------	------	------	------	------	------	------	------	------	------	------	------	------	------	------	------	------	------	------	------	------	------	------	------	------	------	------	------	------	------	------	------	------	------	------	------	------	------	------	------	------	------	------	------	------	------	------	------	------	------	------	------	------	------	------	------	------	------	------	------	------	------	------	------	------	------	------	------	------	------	------	------	------	------	------	------	------	------	------	------	------	------	------	------	------	------	------	------	------	------	------	------	------	------	------	------	------	------	------	------	------	------	------	------	------	------	------	------	------	------	------	------	------	------	------	------	------	------	------	------	------	------	------	------	------	------	------	------	------	------	------	------	------	------	------	------	------	------	------	------	------	------	------	------	------	------	------	------	------	------	------	------	------	------	------	------	------	------	------	------	------	------	------	------	------	------	------	------	------	------	------	------	------	------	------	------	------	------	------	------	------	------	------	------	------	------	------	------	------	------	------	------	------	------	------	------	------	------	------	------	------	------	------	------	------	------	------	------	------	------	------	------	------	------	------	------	------	------	------	------	------	------	------	------	------	------	------	------	------	------	------	------	------	------	------	------	------	------	------	------	------	------	------	------	------	------	------	------	------	------	------	------	------	------	------	------	------	------	------	------	------	------	------	------	------	------	------	------	------	------	------	------	------	------	------	------	------	------	------	------	------	------	------	------	------	------	------	------	------	------	------	------	------	------	------	------	------	------	------	------	------	------	------	------	------	------	------	------	------	------	------	------	------	------	------	------	------	------	------	------	------	------	------	------	------	------	------	------	------	------	------	------	------	------	------	------	------	------	------	------	------	------	------	------	------	------	------	------	------	------	------	------	------	------	------	------	------	------	------	------	------	------	------	------	------	------	------	------	------	------	------	------	------	------	------	------	------	------	------	------	------	------	------	------	------	------	------	------	------	------	------	------	------	------	------	------	------	------	------	------	------	------	------	------	------	------	------	------	------	------	------	------	------	------	------	------	------	------	------	------	------	------	------	------	------	------	------	------	------	------	------	------	------	------	------	------	------	------	------	------	------	------	------	------	------	------	------	------	------	------	------	------	------	------	------	------	------	------	------	------	------	------	------	------	------	------	------	------	------	------	------	------	------	------	------	------	------	------	------	------	------	------	------	------	------	------	------	------	------	------	------	------	------	------	------	------	------	------	------	------	------	------	------	------	------	------	------	------	------	------	------	------	------	------	------	------	------	------	------	------	------	------	------	------	------	------	------	------	------	------	------	------	------	------	------	------	------	------	------	------	------	------	------	------	------	------	------	------	------	------	------	------	------	------	------	------	------	------	------	------	------	------	------	------	------	------	------	------	------	------	------	------	------	------	------	------	------	------	------	------	------	------	------	------	------	------	------	------	------	------	------	------	------	------	------	------	------	------	------	------	------	------	------	------	------	------	------	------	------	------	------	------	------	------	------	------	------	------	------	------	------	------	------	------	------	------	------	------	------	------	------	------	------	------	------	------	------	------	------	------	------	------	------	------	------	------	------	------	------	------	------	------	------	------	------	------	------	------	------	------	------	------	------	------	------	------	------	------	------	------	------	------	------	------	------	------	------	------	------	------	------	------	------	------	------	------	------	------	------	------	------	------	------	------	------	------	------	------	------	------	------	------	------	------	------	------	------	------	------	------	------	------	------	------	------	------	------	------	------	------	------	------	------	------	------	------	------	------	------	------	------	------	------	------	------	------	------	------	------	------	------	------	------	------	------	------	------	------	------	------	------	------	------	------	------	------	------	------	------	------	------	------	------	------	------	------	------	------	------	------	------	------	------	------	------	------	------	------	------	------	------	------	------	------	------	------	------	------	------	------	------	------	------	------	------	------	------	------	------	------	------	------	------	------	------	------	------	------	------	------	------	------	------	------	------	------	------	------	------	------	------	------	------	------	------	------	------	------	------	------	------	------	------	------	------	------	------	------	------	------	------	------	------	------	------	------	------	------	------	------	------	------	------	------	------	------	------	------	------	------	------	------	------	------	------	------	------	------	------	------	------	------	------	------	------	------	------	------	------	------	------	------	------	------	------	------	------	------	------	------	------	------	------	------	------	------	------	------	------	------	------	------	------	------	------	------	------	------	------	------	------	------	------	------	------	------	------	------	------	------	------	------	------	------	------	------	------	------	------	------	------	------	------	------	------	------	------	------	------	------	------	------	------	------	------	------	------	------	------	------	------	------	------	------	------	------	------	------	------	------	------	------	------	-------	-------	-------	-------	-------	-------	-------	-------	-------	-------	-------	-------	-------	-------	-------	-------	-------	-------	-------	-------	-------	-------	-------	-------	-------	-------	-------	-------	-------	-------	-------	-------	-------	-------	-------	-------	-------	-------	-------	-------	-------	-------	-------	-------	-------	-------	-------	-------	-------	-------	-------	-------	-------	-------	-------	-------	-------	-------	-------	-------	-------	-------	-------	-------	-------	-------	-------	-------	-------	-------	-------	-------	-------	-------	-------	-------	-------	-------	-------	-------	-------	-------	-------	-------	-------	-------	-------	-------	-------	-------	-------	-------	-------	-------	-------	-------	-------	-------	-------	-------	-------	-------	-------	-------	-------	-------	-------	-------	-------	-------	-------	-------	-------	-------	-------	-------	-------	-------	-------	-------	-------	-------	-------	-------	-------	-------	-------

/ Frequency-Agile
True Diversity UHF
5000 Series



Designed for use on professional tours, in stadiums, concert halls and festivals with incredible audio quality and proven, critically acclaimed performance for artists, broadcasters and presenters.

/ Frequency-Agile
True Diversity UHF
3000 Series



3000 Series systems have an operating range of 100m and are available in several frequency bands that provide a wide tuning range.

/ Frequency-Agile
True Diversity UHF
2000 Series



Easy to use, flexible to setup, medium - large channel counts, rock solid RF.

/ Antenna Switching Diversity
UHF Wireless Systems
AT-One



Easy to use, for small channel counts, medium operating range, case and rackmount, fairly easy setup.

/ Rack-Mount
Digital Wireless Systems
System 10 Pro



Easy to use, easy to setup remote receiver unit allows professional fixed installations, license-free, no frequency coordination needed.

/ Rack-Mount
Digital Wireless Systems
System 10



Easy to use, easy to setup, license-free, no frequency coordination needed. Short range allows usage of another System 10 setup in an adjacent room.

	Performance				Live Sound					Install			Broadcast & Production			
	Operating range	Indoor range	Outdoor range	Rec. Channel Count	Analog / Digital	Hobby music	Prof. music	Rental company	Theater	School / house of worship /	Corporate / hotel conference room	Large venues / Stadium	Broadcast studio	ENG	Live sport	Film & Location sound
5000 Series	100 m	●●●●	●●●●	> 40	A	○	○○○	○○○	○○○	○	○○○	○○○	○○○		○○○	○○
3000 Series	100 m	●●●●	●●●●	40	A	○○	○○○	○○○	○○○	○○	○○○	○○○	○		○○○	○○
System10 Pro	60 m	●●●	●	10	D	○○	○○	○		○○	○○○					
System10	30 m	●●	●	8	D	○○○	○○	○		○○○	○			○○		○
2000 Series	100 m	●●●●	●●●●	30	A	○○	○	○○	○○	○○○	○○○	○				
AT-One	60 m	●●●	●●●	4	A	○○○	○	○	○	○○○	○○○					



5000 Series

Frequency-Agile True Diversity UHF Wireless Systems

Comprehensive tuning bandwidth

For maximum versatility in ever-congested RF environment, the dual-channel receiver provides a tuning bandwidth of 230 MHz or 120 MHz (depending on frequency band). Both transmitters (ATW-T5202 and ATW-T5201) feature a tuning bandwidth of 120 MHz and are available in different frequency ranges to provide complete coverage of the receiver's bandwidth. This allows the user to set up systems with high channel counts, whilst offering the flexibility to tune to open spectrum wherever you travel.

Dual compander for incredible audio quality

Designed for use on professional tours, in stadiums, concert halls, festivals and other demanding audio environments, the Audio-Technica 5000 Series offers the highest-quality wireless live sound, with dual-compander circuitry that processes high and low frequencies separately for unparalleled frequency response and dynamic range.

Designed for professionals

The body-pack transmitter provides highest possible wearing comfort due to its small size - 64 mm × 70 mm × 17 mm, robust and ergonomic full metal body with concealed soft-touch controls, rugged cH-style connector for secure connection - just to name a few features that meet the needs of professional users.

High channel count

The antenna cascade output connects up to 8 receivers, allowing a single pair of antennas to feed 16 channels of wireless.



Dante®

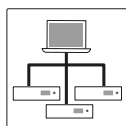

Network



Interchangeable Capsules

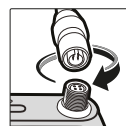

cH-Connector



back

/ Dante® Receiver
ATW-R5220DAN



back

/ Receiver
ATW-R5220



/ Body-Pack Transmitter
ATW-T5201



cH-style screw-down 4-pin connector for secure connection to A-T's cH-style lavalier and headworn microphones, or cables.



/ Interchangeable
Microphone Capsules (IMC)
(see page 4)



/ Handheld Transmitter Body
ATW-T5202

5000 Series

Operating Frequencies	Receiver: Band DG1: 470.125 to 699.875 MHz
	Band GH1: 700.125 to 819.875 MHz
	Transmitter: Band DE1: 470.125 to 590.000 MHz
	Band EG1: 580.000 to 699.875 MHz
	Band GH1: 700.125 to 819.875 MHz
Minimum Frequency Step	25 kHz
Modulation Mode	FM
Operating Range	100 m

ATW-R5220/ATW-R5220DAN

Receiving System	True diversity
Image Rejection	80 dB nominal
Sensitivity	18 dBuV at 60 dBA S/N ratio (50 ohms termination)
Maximum Output Level	XLR, balanced, +18 dBV
Headphone Output	6.3 mm (1/4") TRS stereo 180 mW, typical
Antenna Input	BNC-type, 50 ohms 12 V DC, 150 mA (combined)

ATW-T5201

Frequency Response	23 to 16,300 Hz
Dynamic Range	Mic input: 120 dB or higher (A-weighted), typical Inst input: 107 dB or higher (A-weighted), typical
Input Connection	cH-style screw-down 4-pin connector
Spurious Emissions	Following federal and national regulations
Maximum Deviation	±40 kHz (THD:10%)
Total Harmonic Distortion	1.0 % or less (at 1 kHz, ±17.5 kHz deviation)
RF Power Output	High: 50 mW, Mid: 10 mW, Low: 2 mW (switchable), at 50 ohms
Battery Life	High: 7 hours, Mid: 9 hours, Low: 10.5 hours (alkaline)
Dimensions	64 mm × 70 mm × 17 mm (W × D × H)
Net Weight	Approx. 92 g

ATW-T5202

Frequency Response	33 to 16,300 Hz Depending on attached microphone element
Dynamic Range	116 dB or higher (A-weighted), typical
Microphone Element	Interchangeable industry standard thread
Spurious Emissions	Following federal and national regulations
Maximum Deviation	±40 kHz (THD:10%)
Total Harmonic Distortion	1.0 % or less (at 1 kHz, ±17.5 kHz deviation)
RF Power Output	High: 50 mW, Mid: 10 mW, Low: 2 mW (switchable), at 50 ohms
Battery Life	High: 6.5 hours, Mid: 8 hours, Low: 9.5 hours (alkaline)
Dimensions	193 mm long, 37 mm maximum diameter
Net Weight	200 g



3000 Series

Frequency-Agile True Diversity UHF Wireless Systems

60 MHz tuning bandwidth

The 3000 Series systems are available in several different frequency bands, and each features a wide 60 MHz tuning range. This allows the user to set up systems with high channel counts, whilst offering the flexibility to tune to open spectrum wherever you travel. Frequencies can be easily scanned and selected on the receiver and then synced with the transmitter via IR sync functionality.

Backup frequency button

Unique multifunction button on the handheld and body-pack transmitters can be used to switch to a backup frequency (on both transmitter and receiver) should interference be encountered.

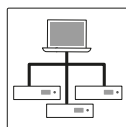

Network

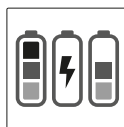

Charging contacts



Interchangeable Capsules



cH-Connector



front



back

/ Receiver
ATW-R3210



back

/ Network-Enabled Receiver
ATW-R3210N



/ Body-Pack Transmitter
ATW-T3201

cH-style screw-down 4-pin connector for secure connection to A-T's cH-style lavalier and headworn microphones, or cables.



/ Interchangeable
Microphone Capsules (IMC)
(see page 4)



/ Handheld Transmitter Body
ATW-T3202





One power supply feeds up to five chargers

Up to five docks can be connected to one power supply (AD-SA1230XA - available separately) to charge a maximum of ten transmitters (per link one AT8687 is required - available separately).

Monitoring and controlling

The ATW-CHG3N networked version of the charging dock allows users to monitor the charging status of all transmitters in the linked docks (per link one AT8687 is required - available separately). Only the first dock must be an ATW-CHG3N, all linked docks (up to four) must be ATW-CHG3.

Protection against misuse

The dock automatically shuts off if alkaline or damaged batteries are detected in the transmitters.



/ Two-Bay Charging Station
ATW-CHG3

/ Two-Bay Networked Charging Station
ATW-CHG3N

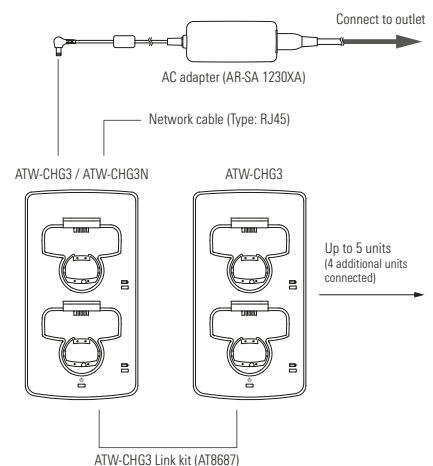



/ Power Supply Unit for ATW-CHG3
AD-SA1230XA

/ Link Kit for ATW-CHG3
AT8687



ATW-CHG3 Charging Station

Charging Time	Approx. 6.5 hours (1,900 mAh rechargeable battery)*
Power Supply	DC12V 3.0A
Power Consumption	4.9W (when 2 transmitters are charging) 27.4W (CHG3×5) (5 units are connected and 10 transmitters are charging)
Weight	400 g
Accessories	Separately available - AC adapter (AD-SA1230XA), ATW-CHG3 Link kit (AT8687)



/ 3000 Series -
Body-pack System
ATW-3211



/ 3000 Series -
Body-pack System with AT831cH
ATW-3211/831



/ 3000 Series -
Body-pack System with BP892xcH
ATW-3211/892x



/ 3000 Series -
Body-pack System with BP892xcH-TH
ATW-3211/892x-TH



/ 3000 Series -
Body-pack System with AT899cH
ATW-3211/899



/ 3000 Series -
Handheld System with ATW-C510
ATW-3212/C510



/ 3000 Series -
Handheld System with ATW-C710
ATW-3212/C710

3000 Series

Operating Frequencies	Band DE2: 470.125 to 529.975 MHz Band EE1: 530.000 to 589.975 MHz Band EF1: 590.000 to 649.975 MHz Band FG1: 650.000 to 699.875 MHz Band GH2: 794.100 to 805.900 MHz Band HH2: 821.100 to 831.900 MHz and 863.100 to 864.900 MHz
------------------------------	--

Minimum Frequency Step	25 kHz
Modulation Mode	FM
Operating Range	100 m

ATW-R3210/ATW-R3210N

Receiving System	True diversity
Image Rejection	60 dB nominal
Sensitivity	20 dBuV at 60 dBA S/N ratio (50 ohms termination)
Maximum Output Level	XLR, balanced, +14 dBV 6.3 mm (1/4), unbalanced: +8 dBV (ATW-R3210 only)
Antenna Input	BNC-type, 50 ohms 12 V DC, 160 mA (combined)

ATW-T3201

Frequency Response	31 to 15,500 Hz
Dynamic Range	Mic input: 115 dB or higher (A-weighted), typical Inst input: 112 dB or higher (A-weighted), typical
Input Connection	cH-style screw-down 4-pin connector
Spurious Emissions	Following federal and national regulations
Maximum Deviation	±38 kHz (THD:10%)
Total Harmonic Distortion	1.0 % or less (at 1 kHz, ±17.5 kHz deviation)
RF Power Output	High: 30 mW, Low: 10 mW (switchable), at 50 ohms
Battery Life	High: 8 hours, Low: 9 hours (alkaline) High: 9 hours, Low: 9.5 hours (Ni-MH 1900mAh)
Dimensions	64 mm × 82 mm × 23 mm (W × D × H)
Net Weight	Approx. 102 g

ATW-T3202

Frequency Response	25 to 16,700 Hz Depending on attached microphone element
Dynamic Range	115 dB or higher (A-weighted), typical
Microphone Element	Interchangeable industry standard thread
Spurious Emissions	Following federal and national regulations
Maximum Deviation	±36 kHz (THD:10%)
Total Harmonic Distortion	1.0 % or less (at 1 kHz, ±17.5 kHz deviation)
RF Power Output	High: 30 mW, Low: 10 mW (switchable), at 50 ohms
Battery Life	High: 8 hours, Low: 9 hours (alkaline) High: 9 hours, Low: 9.5 hours (Ni-MH 1900mAh)
Dimensions	193 mm long, 37 mm maximum diameter
Net Weight	200 g



2000 Series

Frequency-Agile True Diversity UHF Wireless Systems

Easy to use

Easy setup, automatic scanning and other advanced wireless features - affordable as never before. Though the 2000b system is designed for professional use, the user does not need special training to operate it. Once unboxed, it's ready to roll! Standard automatic frequency scanning finds and sets the best available channel at the touch of a button. Using multiple wireless systems simultaneously, as any of its 10 preset channels can be used together.

12V antenna power

The ATW-R2100b receiver delivers a bias voltage of 12V / 60mA from each BNC antenna input, enabling the use of antenna boosters or other active components.

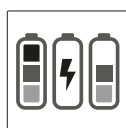

Charging contacts

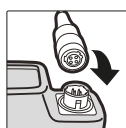

cW-Connector



front



back



Locking 4-pin microphone connector for use with Audio-Technica cW-style wireless body-pack transmitters.

/ Body-pack Transmitter
ATW-T210a



/ Two-Bay Recharging Station
ATW-CHG2



/ Handheld Transmitter
ATW-T220a

2000 Series

Operating Frequencies	I Band: 487.125 to 506.500 MHz U Band: 606.500 to 631.000 MHz D Band: 656.125 to 678.500 MHz F Band: 854.900 to 864.900 MHz
Max. Number of Channels	10
Modulation Mode	FM
Operating Range	100 m

ATW-R2100b

Receiving System	True diversity
Image Rejection	55 dB nominal, 50 dB minimum
Sensitivity	20dB μ V (S/N 60dB at 5 kHz deviation, IEC-weighted)
Maximum Output Level	XLR, balanced, +14 dBV - 6.3 mm (1/4), unbalanced: +8 dBV
Antenna Input	BNC-type, 50 ohms 12 V DC, 60 mA (each)

ATW-T210a

Frequency Response	100 to 15,500 Hz
Dynamic Range	110 dB or higher (A-weighted), typical
Input Connection	cH-style screw-down 4-pin connector
Spurious Emissions	Following federal and national regulations
Maximum Deviation	\pm 40 kHz (THD:10%)
Total Harmonic Distortion	1.0 % or less (at 1 kHz, \pm 17.5 kHz deviation)
RF Power Output	High: 30 mW, Low: 10 mW (switchable)
Battery Life	High: 7 hours, Low: 9 hours (alkaline)
Dimensions	66 mm \times 92 mm \times 23 mm (W \times D \times H)
Net Weight	Approx. 81 g

ATW-T220a

Frequency Response	100 to 15,000 Hz
Dynamic Range	110 dB or higher (A-weighted), typical
Microphone Element	Cardioid, dynamic
Spurious Emissions	Following federal and national regulations
Maximum Deviation	\pm 40 kHz (THD:10%)
Total Harmonic Distortion	1.0 % or less (at 1 kHz, \pm 20 kHz deviation)
RF Power Output	High: 30 mW, Low: 10 mW (switchable)
Battery Life	High: 7 hours, Low: 9 hours (alkaline)
Dimensions	232 mm long, 48 mm maximum diameter
Net Weight	252 g

-  / 2000 Series - Body-pack System
ATW-2110b

-  / 2000 Series - Body-pack System with AT-GcW
ATW-2110b/G

-  / 2000 Series - Body-pack System with PR08HEcW
ATW-2110b/H

-  / 2000 Series - Body-pack System with ATM75cW
ATW-2110b/HC1

-  / 2000 Series - Body-pack System with ATM73cW
ATW-2110b/HC2

-  / 2000 Series - Body-pack System with AT829cW
ATW-2110b/P

-  / 2000 Series - Body-pack System with AT899cW
ATW-2110b/P1

-  / 2000 Series - Body-pack System with AT831cW
ATW-2110b/P2

-  / 2000 Series - Body-pack System with MT838cW
ATW-2110b/P3

-  / 2000 Series - Handheld System
ATW-2120b



AT-One

Wireless System

Easy to use

AT-One is designed with simplicity and ease-of-use in mind. Equipped with a practical carrying case, rack-mount kit and detachable antenna, AT-One is the perfect balance of price and performance, ideal for those looking for accurate, reliable performance at an entry-level price.

The AT-One's frequency plan is divided into two groups with four available channels in each group. All four channels in a group can be used simultaneously.

Cardioid condenser capsule – induction loop ready

The condenser microphone capsule in the ATW-T1 handheld transmitter prevents inductive feedback from nearby hearing loops.

12V antenna power

The ATW-R1 receiver delivers a bias voltage of 12V / 100mA from each BNC antenna input, enabling the use of antenna boosters or other active components.



cW-Connector



front

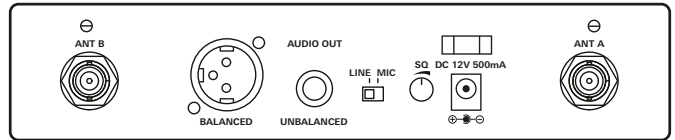

back



Locking 4-pin microphone connector for use with Audio-Technica cW-style wireless body-pack transmitters.

/ Body-pack Transmitter
ATW-T1

/ Receiver
ATW-R1



/ Handheld Transmitter
ATW-T3



/ AT-One -
Body-pack System
ATW-11



/ AT-One -
Body-pack System with AT-GcW
ATW-11/G



/ AT-One -
Body-pack System with PR09cW
ATW-11/H



/ AT-One -
Body-pack System with ATR35cW
ATW-11/P



/ AT-One -
Handheld System
ATW-13

AT-One

Operating Frequencies	Band DE3: 482.625 to 511.375 MHz Band HH2: 824.400 to 830.850 MHz & 863.300 to 864.700 MHz
Max. Number of Channels	2 x 4
Modulation Mode	FM
Operating Range	60 m

ATW-R1

Receiving System	Antenna switching diversity
Image Rejection	55 dB minimum
Sensitivity	10 dB μ V (S/N 60 dB @ 20 kHz deviation)
Maximum Output Level	XLR, balanced, +4 dBV - 6.3 mm (1/4), unbalanced: -2 dBV
Antenna Input	BNC-type, 50 ohms 12 V DC, 100 mA (each)

ATW-T1

Frequency Response	60 to 16,000 Hz
Dynamic Range	103 dB or higher (A-weighted), typical
Input Connection	cW-style lock-down 4-pin connector
Spurious Emissions	Following federal and national regulations
Maximum Deviation	\pm 40 kHz (THD:10%)
Total Harmonic Distortion	1.0 % or less (at 1 kHz, -20 kHz deviation)
RF Power Output	10 mW
Battery Life	10 hours (alkaline)
Dimensions	66 mm x 98 mm x 22 mm (W x D x H)
Net Weight	Approx. 71 g

ATW-T3

Frequency Response	60 to 16,000 Hz
Dynamic Range	108 dB or higher (A-weighted), typical
Microphone Element	Cardioid, condenser
Spurious Emissions	Following federal and national regulations
Maximum Deviation	\pm 40 kHz (THD:10%)
Total Harmonic Distortion	1.0 % or less (at 1 kHz, -20 kHz deviation)
RF Power Output	10 mW
Battery Life	10 hours (alkaline)
Dimensions	268 mm long, 52 mm maximum diameter
Net Weight	277 g

System 10

Digital Wireless Systems

Easy to use

System 10 is a digital high-fidelity wireless system designed to provide 24-bit operation, easy setup and clear, natural sound quality. Operating in the 2.4 GHz range, far from TV and DTV interference, System 10 offers extremely easy operation and instantaneous channel selection. Up to eight channels may be used together without any frequency coordination problems or group selection issues. System 10 receivers and transmitters offer an easy-to-read digital ID display.

Three levels of diversity assurance

System 10 provides three levels of diversity: frequency, time and space. Frequency diversity transmits the signal on two frequencies simultaneously for better protection against frequency interference. Time diversity sends the signal twice to maximise signal integrity. Finally, space diversity uses two antennas on each transmitter and receiver to optimize immunity against multipath interference.



Frequency



cW-Connector



System 10 PRO

Digital Wireless Systems

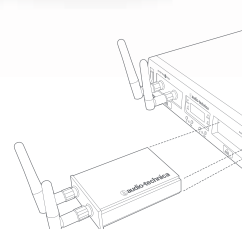

Featuring
Remote-Mountable
Receiver Units

A compact and expandable system

With an RJ12 cable supplied with each system, it is possible to connect up to 5 frames (10 receivers). While many systems can operate without being connected, this is not recommended. Indeed, linking the systems to create a more stable environment in which receivers are coordinated for the reception, transmission and frequency allocation avoids signal loss and optimizes the simultaneous use of the 10 channels.



/ Single Channel Receiver
ATW-R1310

front



/ Dual Channel Receiver
ATW-R1320

front

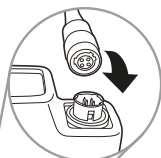

Locking 4-pin microphone connector for use with Audio-Technica cW-style wireless body-pack transmitters.



back



/ Body-Pack Transmitter
ATW-T1001

(specifications, see page 20)



/ Boundary Microphone Transmitter
ATW-T1006



/ Microphone Desk Stand Transmitter
ATW-T1007



/ Handheld Transmitter-
ATW-T1002

(specifications, see page 20)



/ System 10 PRO -
Rack-Mount Digital Wireless System
ATW-1301



/ System 10 PRO -
Rack-Mount Digital Wireless System
ATW-1311



/ System 10 PRO -
Rack-Mount Digital Wireless System
ATW-1312



/ System 10 PRO -
Rack-Mount Digital Wireless System
ATW-1302



/ System 10 PRO -
Rack-Mount Digital Wireless System
ATW-1322

System 10 PRO

Operating Frequencies	2.4 GHz ISM Band
Max. Number of Channels	10
Audio Sampling	24 bit / 48 kHz
Operating Range	60 m

ATW-R1310 & ATW-R1320

Receiving System	Diversity (frequency / time / space)
Maximum Output Level	XLR, balanced, +6 dBV - 6.3 mm (1/4), unbalanced: 0 dBV

ATW-T1006

Maximum Input Sound Level	139 dB SPL
RF Power Output	10 mW
Spurious Emissions	Following federal and national regulations
Internal Battery	3.7 V Rechargeable Li-ion Battery
Battery Rating	5.5 Wh; 1,460 mAh
Battery Life	9 hours (Battery charging time: 4 hours 30 minutes)
Dimensions	96.1 mm W × 38.0 mm H × 122.8 mm D
Net Weight	408 grams

ATW-T1007

RF Power Output	10 mW
Spurious Emissions	Following federal and national regulations
Phantom Power	12V DC
Internal Battery	3.7 V Rechargeable Li-ion Battery
Battery Rating	5.5 Wh; 1,460 mAh
Battery Life	9 hours (Battery charging time: 4 hours 30 minutes)
Dimensions	96.1 mm W × 44.2 mm H × 122.8 mm D
Net Weight	392 grams

ATW-T1001 & ATW-T1002 (specifications, see page 20)



System 10

Digital Wireless Systems

Automatic frequency selection

The System 10 automatically changes its frequency. Unlike other systems on the market that attach to 2 or 4 frequency, the System 10 will constantly “monitor” the frequencies and switch if necessary. Thus, there are always a good 2 frequencies in the system, and the user does not need to manually intervene.



/ Receiver
ATW-R1100



Locking 4-pin microphone connector for use with Audio-Technica cW-style wireless body-pack transmitters.

/ Body-Pack Transmitter
ATW-T1001



Handheld Transmitter /
ATW-T1002



/ System 10 -
Body-pack System
ATW-1101



/ System 10 -
Handheld System
ATW-1102

System 10 - Stack-Mount

Operating Frequencies	2.4 GHz ISM Band
Max. Number of Channels	8
Audio Sampling	24 bit / 48 kHz
Operating Range	30 m

ATW-R1100

Receiving System	Diversity (frequency / time / space)
Maximum Output Level	XLR, balanced, +6 dBV - 6.3 mm (1/4), unbalanced: 0 dBV

ATW-T1001

Frequency Response	20 to 20,000 Hz
Dynamic Range	109 dB or higher (A-weighted), typical
Input Connection	cW-style lock-down 4-pin connector
Spurious Emissions	Following federal and national regulations
Total Harmonic Distortion	0.05 % or less
RF Power Output	10 mW
Battery Life	7 hours (alkaline)
Dimensions	72 mm × 107 mm × 25 mm (W × D × H)
Net Weight	Approx. 100 g

ATW-T1002

Frequency Response	20 to 20,000 Hz
Dynamic Range	109 dB or higher (A-weighted), typical
Microphone Element	Unidirectional, dynamic
Spurious Emissions	Following federal and national regulations
Total Harmonic Distortion	0.05 % or less
RF Power Output	10 mW
Battery Life	7 hours (alkaline)
Dimensions	255 mm long, 50 mm maximum diameter
Net Weight	280 g



System 10 Camera-Mount

Portable Camera-Mount Digital Wireless Systems

Small and compact design

With its compact and portable design, the System 10 Digital Wireless Camera System is ideal for video production, reporting and all intermediate mobile applications, the receiver offers several mounting options to suit a wide variety of cameras and recording devices. Each System 10 camera mount wireless system includes a camera mounting spigot in addition to the receiver and the transmitter.



System 10 -
Camera-mount Body-pack System
ATW-1701



/ System 10 -
Camera-mount Body-pack System
with AT8350
ATW-1701x3M



/ System 10 PRO -
Camera-mount Body-pack System
with AT829cW
ATW-1701/P1



/ System 10 -
Camera-mount Handheld System
ATW-1702



/ System 10 -
Camera-mount Handheld System
with AT8350
ATW-1702x3M

/ Camera-Mount Receiver
ATW-R1700



/ Body-Pack Transmitter
ATW-T1001 (see page 20)

/ Handheld Transmitter
ATW-T1002 (see page 20)

System 10 - Camera-Mount

Operating Frequencies	2.4 GHz ISM Band
Max. Number of Channels	8
Audio Sampling	24 bit / 48 kHz
Operating Range	30 m

ATW-R1700

Receiving System	Diversity (frequency / time / space)
Maximum Output Level	3.5 mm, TRS balanced, +6 dBV 3.5 mm, TRS unbalanced: 0 dBV
Battery Type	Internal Battery: 3.7V rechargeable Li-ion battery
Battery Life	12 hours (Battery charging time: 4 hours 30 minutes)
Dimensions	56 mm × 91 mm × 28 mm (W × D × H)
Weight	Approx 105 g

ATW-T1001 & ATW-T1002 (specifications, see page 20)

Connected Accessory			ATW-A49	ATW-A410P	ATW-B80WB	ATW-49CB	ATW-49SP	ATW-DA49a
Current Requirement			0 mA	60mA	60mA	30mA	30mA	0 mA
Used wireless system		Current per antenna input @12V						
AT-One	ATW-R1	100 mA	+	1 pair	1 pair	2 pair	1 pair (*)	+
2000 Series	ATW-R2100	60 mA	+	1 pair	1 pair	2 pair	1 pair (*)	+
3000 Series	ATW-R3210	80 mA	+	1 pair	1 pair	2 pair	1 pair (*)	+
5000 Series	ATW-R5220	75 mA	+	1 pair	1 pair	2 pair	1 pair (*)	+
System 10	All receiver	-	-	-	-	-	-	-
Distribution amplifier	ATW-DA49A	250 mA	+	2 pair (**)	4 pair	2 pair (***)	1 pair (*)	See application 6

(*) Although possible to power more than 1 pair it is recommended to use an ATW-DA49a instead.

(**) You would require to use a pair of ATW-49CB to connect 2 pairs of antennas.

(***) 2 pairs would allow to connect 4 pairs of passive antennas (A49) - no active antennas.

Please use the above table to determine the maximum numbers of active componets in the antenna cable run.

Example: AT-One (100 mA per antenna cable run) could drive 1 pair of ATW-B80WB boosters and 1 pair of ATW-49SP splitter. (60 mA + 30 mA = 90 mA).

Example: ATW-DA49a (250 mA per antenna cable run) could drive 2 pairs of ATW-A49 (0 mA), 2 pairs of ATW-B80WB boosters (2x 60mA per antenna run) and 1 pair of ATW-49CB (30 mA): Total: 2x 150 mA.

ATW-DA49a

UHF Antenna Distribution Systems



Durability

The ATW-DA49a provides a high OIP3 (+ 32 dBm) for maximum protection against intermodulation.

Specifications	ATW-DA49a
Antenna Power (optional)	12V DC, 250 mA (combined)
Current Consumption	200 mA ± 50 mA at 12 V DC
Gain	+1.0dB typical (within specified bandwidth)
Input	2 x 1 inputs
OIP3	+32dBm typical (within specified bandwidth)
Output	2 x 4 outputs + 1 cascade output - BNC Female
Operating Bandwidth	470-990 MHz
Power Supply	100-240V AC (50/60 Hz) to 12V DC 1A (centre positive) switched mode external power supply

/ Active Antenna Combiner Kit (pair) ATW-49CB



/ Active Antenna Splitter Kit (pair) ATW-49SP



Specifications	ATW-49SP	ATW-49CB
Description	2-Way Active Antenna Splitter	2-Input Active Combiner
Bandwidth	440 MHz to 900 MHz	440 MHz to 900 MHz
VSWR	< 1.7:1 (within specified bandwidth)	< 1.7:1 (within specified bandwidth)
Gain	0 dB typical (within specified bandwidth)	0 dB typical (within specified bandwidth)
Impedance	50 ohms, typical (within specified bandwidth)	50 ohms, typical (within specified bandwidth)
Termination Type	3-BNC Female	3-BNC Female
Weight	51 g	51 g
Dimensions	61 mm W x 47 mm L x 23 mm H	61 mm W x 47 mm L x 23 mm H
DC Input	5-14V DC	5-14V DC
Current	30 mA @ 12V DC	30 mA @ 12V DC
Pass-through Current	100 mA	120 mA (maximum to both inputs combined)



/ UHF Wide-Band Directional LPDA Antennas (pair)
ATW-A49

Specifications	ATW-A49
Antenna Type	Log Periodic Dipole Array (LPDA)
Operating Bandwidth	440 – 900 MHz
Gain	6 dB typical*
Impedance	50 ohms typical*
VSWR	≤ 1.7:1*
Polar Pattern	Elliptical, 90° acceptance, typical
Polarization	Vertical (when mounted vertically)
Number of Elements	9
Maximum Power Input	Not specified (intended as receive antenna only)
Termination Type	Fixed right-angle BNC female Connector is positioned to minimize cable strain
Weight	326 g each
Dimensions	268 mm L x 285 mm H x 25 mm D
Material	Copper-clad epoxy fiberglass



/ UHF Powered Wideband Antenna (single)
ATW-A410P

Specifications	ATW-A410P
Gain	-10 dB / 0 dB / +6 dB / +12 dB
OIP3	> 30 dBm typical (within specified bandwidth)
Termination Type	BNC-J
Operating Bandwidth	470-990 MHz
Operating Temperature Range	-10°C to 50°C
Dimensions	175 x 175 x 50 mm (without bracket)
Weight	390 g (without bracket)
Accessories	Mounting bracket, screws
Impedance	50 ohms typical (within specified bandwidth)
Power Consumption	60mA



/ In-Line RF booster 470-990MHz 6dB / 12dB (pair)
ATW-B80WB

Specifications	ATW-B80WB
Connections	BNC-J (IN), BNC-J (OUT)
Power Supply	DC 12 V
Frequency Range	470 - 990 MHz
Impedance	50 ohms
Power Consumption	60mA
Gain High	+12 dB Red, +6 dB Green
Connections	BNC-J (IN), BNC-J (OUT)
Power Supply	DC 12 V



/ 0.9m RF Antenna Cable
AC3



/ 4m RF Antenna Cable
AC12



/ 8m RF Antenna Cable
AC25



/ 15m RF Antenna Cable
AC50

/ Antenna Front-Mount Kit
ATW-AF1

For ATW-DA49a



/ Universal Joining Plate for AT 9.5" devices
AT8631

*For ATW-R3210, ATW-R3210N, ATW-R2100b,
ATW-R1300, ATW-R1310, ATW-R1320
and other AT 9.5" devices*

/ Receiver Unit Wall-Mount Holder
AT8690

For System 10 PRO, ATW-RU13



/ Camera Shoe Dual Mount
AT8691

For System 10, ATW-R1700



/ 3.5 mm - XLR Cable (ATW-R1700)
AT8350



/ 3.5 mm - 3.5 mm Cable (ATW-R1700)
AT8349



/ Dual Rack-Mount Kit
AT8677

For AT-One, ATW-R1



/ Rack-Mount Tray
AT8674









For System 10, ATW-R1100

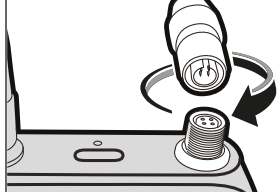
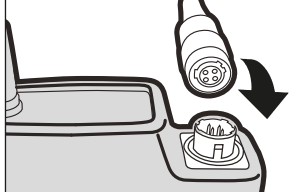

/ Blanking Plate
AT8675

For AT8674



		cH-Version	cW-Version
			
	<p>/ Subminiature Omnidirectional Condenser Headworn Microphone</p>	<p>BP892xcH & BP892xcH-TH</p>	<p>BP892xcW & BP892xcW-TH</p>
	<p>/ Subminiature Omnidirectional Condenser Headworn Microphone</p>	<p>BP893xcH & BP893xcH-TH</p>	<p>BP893xcW & BP893xcW-TH</p>
	<p>/ Subminiature Cardioid Condenser Headworn Microphone</p>	<p>BP894xcH & BP894xcH-TH</p>	<p>BP894xcW & BP894xcW-TH</p>
	<p>/ Cardioid Condenser Headworn Microphone</p>	<p>ATM73cH</p>	<p>ATM73cW</p>
	<p>/ Cardioid Condenser Headworn Microphone</p>	<p>ATM75cH</p>	<p>ATM75cW</p>
	<p>/ Hypercardioid Dynamic Headworn Microphone</p>	<p>PRO8HEcH</p>	<p>PRO8HEcW</p>
	<p>/ Cardioid Condenser Headworn Microphone</p>	<p>PRO9cH</p>	<p>PRO9cW</p>
	<p>/ Omnidirectional Condenser Headworn Microphone</p>	<p>PRO92cH & PRO92cH-TH</p>	<p>PRO92cW & PRO92cW-TH</p>

		cH-Version	cW-Version
			
	/ Subminiature Cardioid Condenser Lavalier Microphone	AT898cH	AT898cW
	/ Subminiature Omnidirectional Condenser Lavalier Microphone	AT899cH & AT899cH-TH	AT899cW & AT899cW-TH
	/ Miniature Cardioid Condenser Lavalier Microphone	AT831cH	AT831cW
	/ Miniature Omnidirectional Condenser Lavalier Microphone	AT803cH	AT803cW
	/ Cardioid Condenser Lavalier Microphone	AT829cH	AT829cW
	/ Omnidirectional Condenser Lavalier Microphone		MT838cW
	/ Omnidirectional Condenser Lavalier Microphone	MT830cH	MT830cW
	/ Omnidirectional Condenser Lavalier Microphone		ATR35cW

		cH-Version	cW-Version
			
	<p>/ Cardioid Condenser Instrument Microphone w/ Universal Clip-on Mounting System</p>	<p>ATM350UcH</p>	<p>ATM350UcW</p>
	<p>/ Cardioid Condenser Clip-on Instrument Microphone</p>	<p>PRO35cH</p>	<p>PRO35cW</p>
	<p>/ Professional Guitar Input Cable</p>	<p>AT-GcH PRO</p>	<p>AT-GcW PRO</p>
	<p>/ Professional Guitar Input Cable Angled</p>	<p>AT-GRcH PRO</p>	<p>AT-GRcW PRO</p>
	<p>/ Guitar Input Cable</p>	<p>AT-GcH</p>	<p>AT-GcW</p>
	<p>/ Microphone Input Cable</p>	<p>XLRcH</p>	<p>XLRW</p>
	<p>/ Adapter Cable</p>	<p>AT-cWcH</p>	

Dual-channel wireless system

When more than one wireless microphone system is required, you may find that in certain circumstances using two receivers side-by-side with individual antennas is unsuitable. For example, where the receiver needs to be placed out of sight or in a different room, such as installation for a multi-purpose venue, house of worship or a small live music performance.

The solution is to utilise one pair of antennas placed in the room to feed both the receivers. The signal is passed from the room over two 50 Ohm RF cables to the receivers' location, where the antenna signals are split into each receiver using the ATW-49SP Active Antenna Splitter Kit.

Check the signal loss of the antenna cable, based on the frequency range of your system and the specified antenna cable length and type. Audio-Technica's wireless manager software offers a "cable loss calculation tool" to do so. If the dB loss exceeds 7 dB, you should consider including the ATW-B80WB In-Line RF Booster as each 6dB of loss across the signal chain will reduce your systems operating distance by 50%.

The ATW-A49SP is powered by the receivers across the antenna cable – no external power source is required. Though our example includes the ATW-A49 LPDA Antenna, any passive antennas can be used provided they support the frequency range of your wireless systems.

If you require an active antenna like our ATW-A410P, or other active components such as the ATW-B80WB, then check the total current consumption of the individual products (simply add their stated mA together per RF cable run) to make certain that your receiver delivers the necessary power.

Compatible Audio-Technica wireless systems for this solution include the AT-One, 2000 Series and 3000 Series.

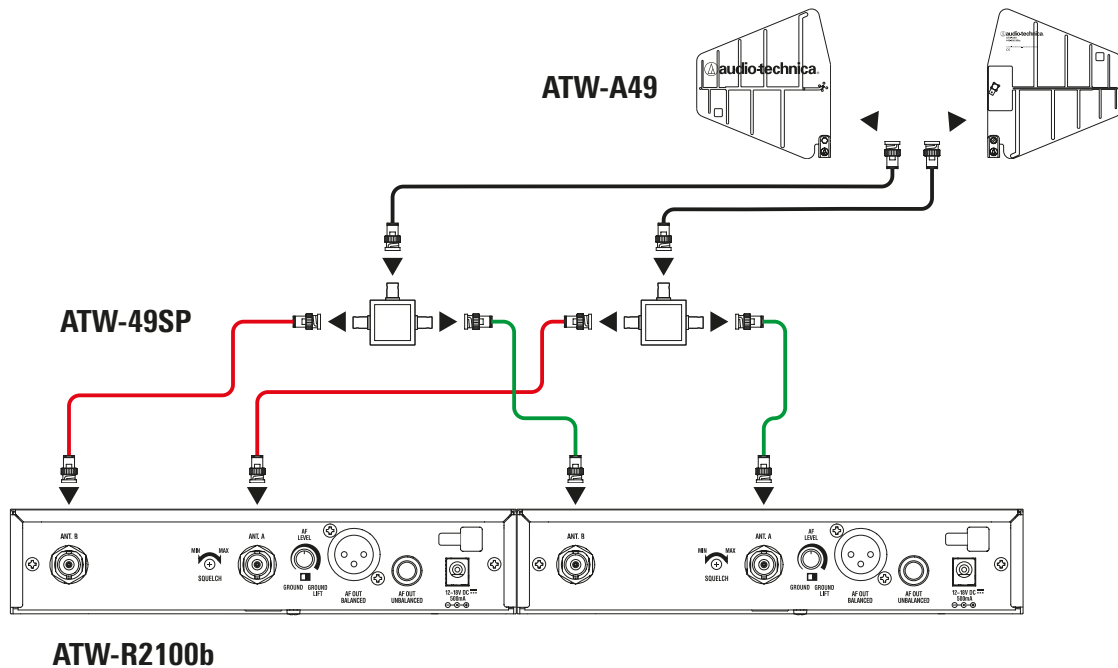

Product table

Quantity	Code	Description	Alternative
2	ATW-R2100b	Frequency-agile True Diversity UHF Wireless Receiver	
2	ATW-T210a	2000a Series UniPak™ Transmitter	ATW-T220a Handheld Transmitter
1	ATW-A49	Pair of UHF Wide-band Directional LPDA Antennas	
1	ATW-49SP	Active Antenna Splitter Kit	
2	AC25	25'/7.6m RF Antenna Cable	AC12, AC50

Single-channel wireless system covering two zones

In some situations, only one wireless system is required, but there is the need to guarantee coverage over two separate areas. This, in most cases, is simply not achievable using one pair of antennas. An example of this would be when needing to cover an indoor area and its associated outdoor space, such as you may find in a restaurant, bar, or house of worship setting. Alternatively, a client may have a hotel ballroom which also divides into two multi-function areas, resulting in the need to cover the sections individually.

To achieve this solution, you will need two pairs of antennas – one pair per area requiring coverage. Then, the four antenna cables run to the receiver location, and they are combined using the ATW-49CB Active Antenna Combiner Kit. The resulting two antenna cables can then connect directly to the wireless receiver. Take care to position the ATW-49CB as close to the antennas as possible, to minimise the quantity of antenna cable required in the installation – this will improve signal integrity and reduce cost for the customer.

Refer to the notes in Application 1 for advice on specifying cable length, active antennas and boosters in the cable run.

If the receiver in use can provide adequate current, it is possible to combine Application 1 and Application 2 to create a dual-channel wireless solution with the ability to cover two zones – simply add the ATW-49SP between the ATW-49CB and the receiver.

Compatible Audio-Technica wireless systems for this solution include the AT-One, 2000 Series, 3000 Series and 5000 Series.

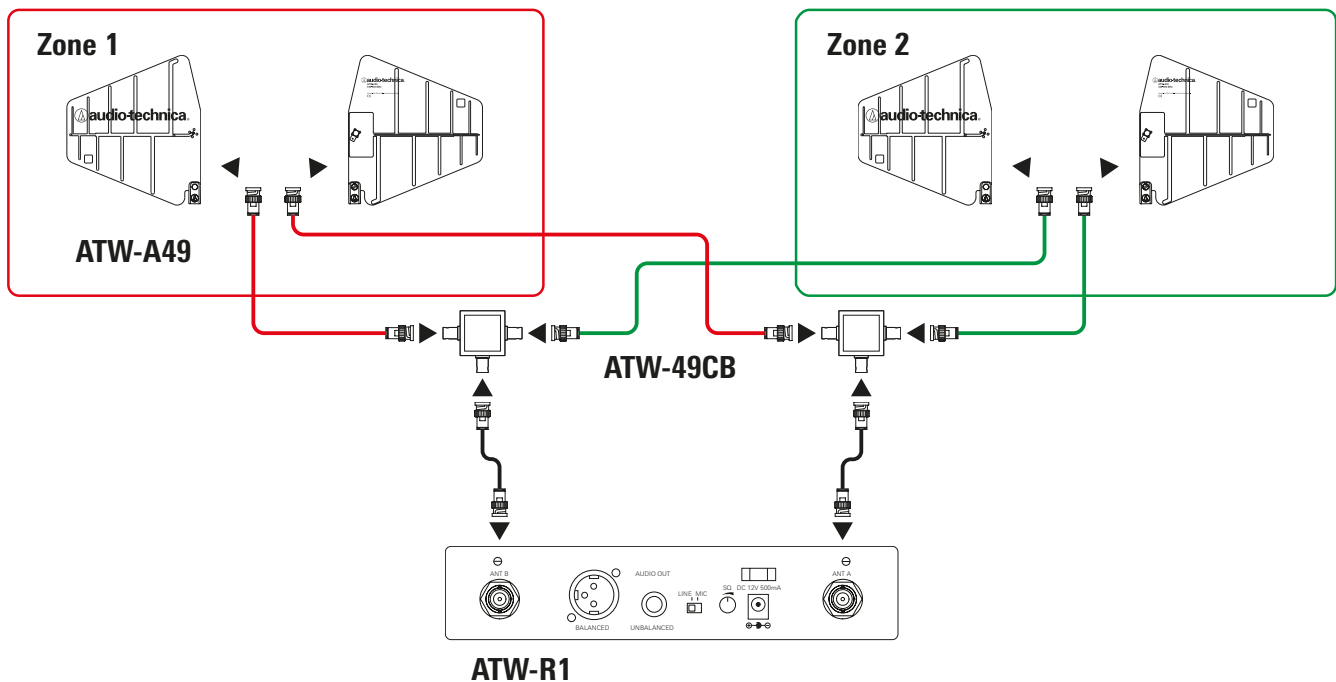

Product table

Quantity	Code	Description	Alternative
1	ATW-R1	Frequency-agile True Diversity UHF Wireless Receiver	
1	ATW-T1	AT-One Beltpack Transmitter	ATW-T3 Handheld Transmitter
2	ATW-A49	Pair of UHF Wide-band Directional LPDA Antennas	
1	ATW-49CB	Active Antenna Combiner Kit	
4	AC25	25/7.6m RG8 Antenna Cable	AC12, AC50

Multiple zones wireless system

If you need to cover more than two areas which are in proximity of one another, or you simply need to cover one very large area, then this solution may suit your requirements. Consider the need for a wireless microphone which needs to operate throughout the areas of a shopping mall, or over the very wide area of a sports venue – such as a golf course.

Initially, you may consider using multiple pairs of antennas, combining them with multiple ATW-49CB. However, this is not usually the best approach, as you will either run into power issues or the total cable runs will become too long to compensate for incurred RF loss with signal boosters.

This application offers a more elegant solution. The concept begins with placing a wireless receiver of the same type, tuned to the same frequency, in each area with a local pair of antennas.

If you were to use these receivers alone, you could operate the transmitter in each room, provided you activate only one receiver at a time. Then, the audio signal can be sent from the active receiver to the local speaker system as needed. In this scenario, you must manually switch off or mute the unused receivers in order to avoid erratic audio signals being output whilst the wireless transmitter is out of range.

In most cases, this option is not practical. It may not be possible to continually ensure unused receivers are switched off between uses, or a project may demand that the wireless transmitter must work across all areas freely – without continual adjustment by a technician.

The solution is to add the ATDM-0604 Digital SmartMixer. Simply connect the audio signals from each receiver to the ATDM-0604 and set the unit to Smart Mix mode, making sure to allow only one open microphone at a time. This way, a receiver remains active in the mixer until an audio drop out occurs, which will trigger the mixer to automatically switch to the receiver featuring the most reliable signal. With this solution, you can combine up to six areas, whilst creating one reliable output signal.

Check Application 1 for important information on total cable length, active antennas or using boosters in your antenna cable run. It is possible to combine Application 3 with Application 2 in some or all zones to increase the area of coverage even further. Also, it is possible to combine Application 3 with Application 4. In this case, you will require one ATDM mixer for each wireless microphone you want to use.

Compatible Audio-Technica wireless systems for this solution include the AT-One, 2000 Series and 3000 Series.



Product table

Quantity	Code	Description	Alternative
6	ATW-R2100b	Frequency-Agile True Diversity UHF Wireless Receiver	
1	ATW-T210a	2000 Series Beltpack Transmitter	ATW-T220a Handheld Transmitter
1	ATDM-0604	Digital SmartMixer	

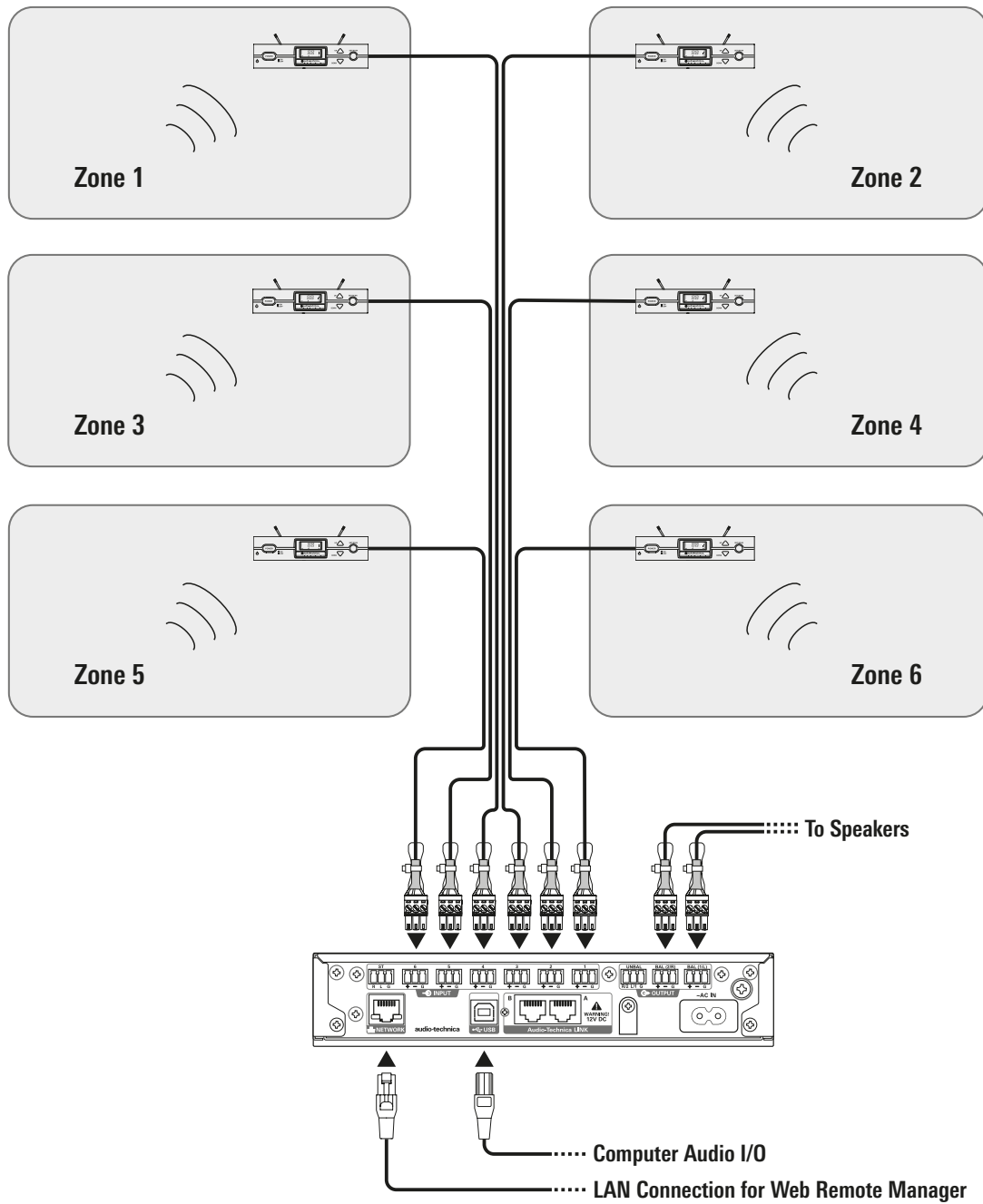

Equipment used

ATDM-0604



6 x ATW-R2100b



ATW-T210a

1 x

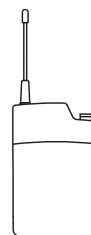

or

ATW-T220a

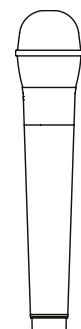

Four-channel wireless system

A four-channel wireless system is often required by live music acts, podium discussions, or in fixed installations for multi-purpose rooms. Rental companies may also design their wireless systems in blocks of four channels for small to medium sized events, as these racks are easy to handle whilst being easily scaled up to a larger system when required (see Application 6).

This solution is similar in design to Application 1. The primary difference is the inclusion of the ATW-DA49a, which can divide the incoming pair of antenna signals into four individual signal pairs to feed each receiver. However, this change does not only offer more outputs. In Application 1, the ATW-49SP is powered by the receiver, while in this setup the ATW-DA49a is powered by mains voltage. As a result, the ATW-DA49a distribution amplifier can provide significantly more antenna power for active components in the cable run. Due to the higher current this unit can deliver, it is possible to realise much longer cable runs, with more than one ATW-B80WB booster, as well as drive antenna combiners and active antennas before reaching a power limitation.

Check Application 1 for important information on total cable length, active antennas or using boosters in your antenna cable run. This application can be combined with Application 2 and is the core design for achieving Application 6.

Compatible Audio-Technica wireless systems for this solution include the AT-One, 2000 Series and 3000 Series.



Product table

Quantity	Code	Description	Alternative
4	ATW-R3210	Frequency-Agile True Diversity UHF Wireless Receiver	ATW-R3210N
4	ATW-T3201	3000 Series Beltpack Transmitter	ATW-T3202 Handheld Transmitter
1	ATW-DA49a	UHF Antenna Distribution System	
1	ATW-A49	Pair of UHF Wide-band Directional LPDA Antennas	ATW-A410P
1	ATW-B80WB	Pair of In-Line RF boosters 470-990MHz	
4	AC25	25/7.6m RG8 Antenna Cable	AC12, AC50, AC100

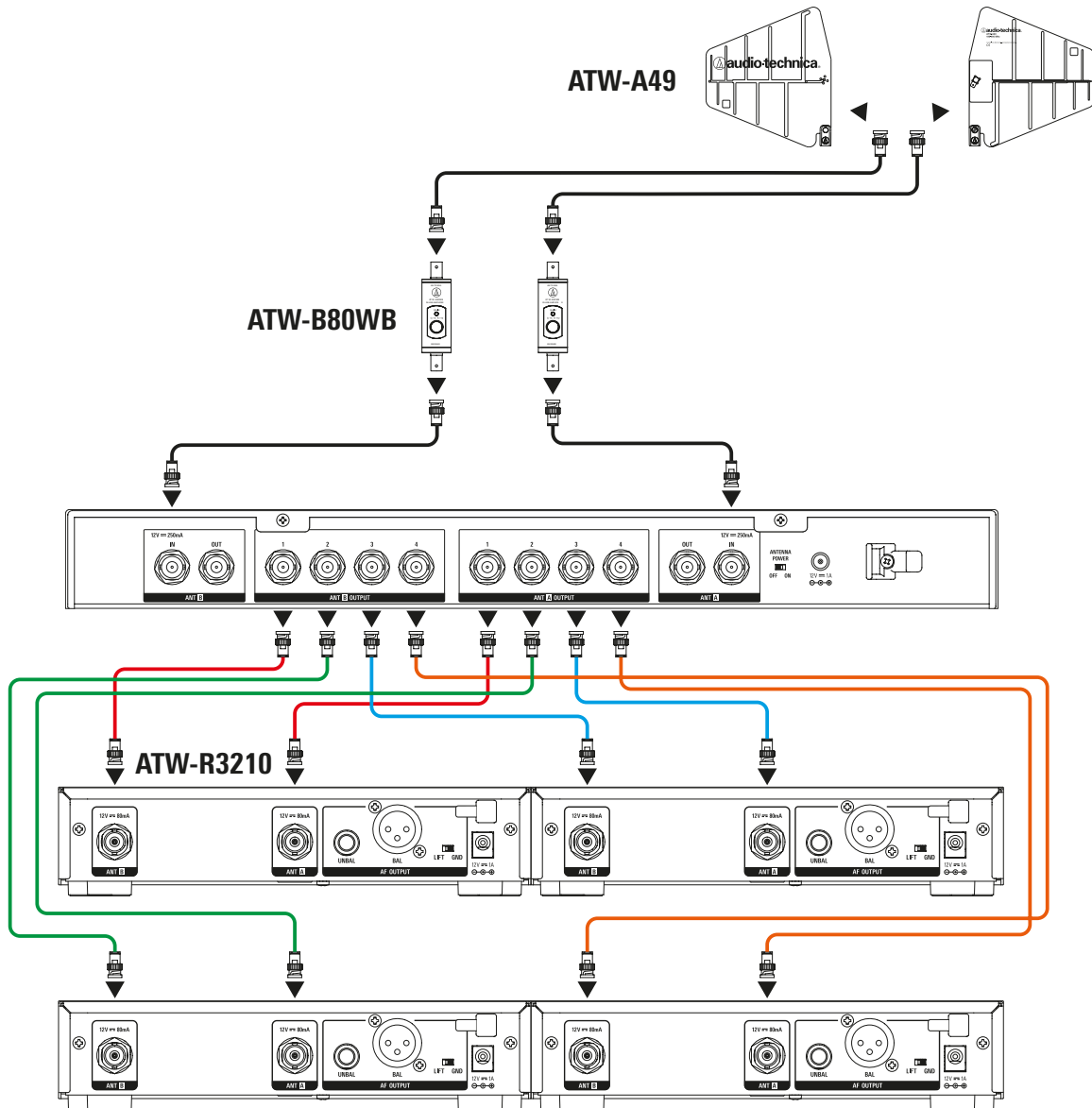

Equipment used

ATW-DA49a



ATW-A49

ATW-B80WB

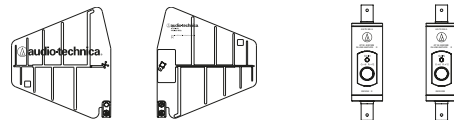

4 x ATW-R3210

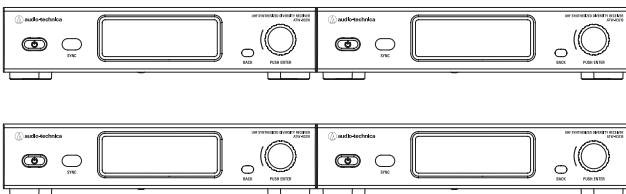

ATW-T3201

ATW-T3202

4 x

or

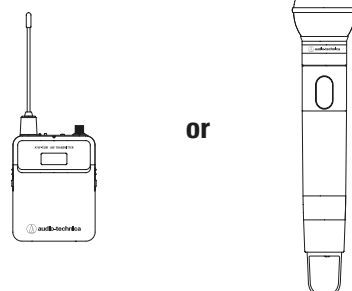

Multi-channel wireless system for install

This solution is aimed at fixed installations where the use of UHF TV bands is not preferred, such as in locations with a restricted RF environment or where the customer wishes to avoid licensing costs and the need for frequency coordination. Typical applications for this include educational facilities such as schools or universities, multi-function rooms, or conference centres.

This application is based around our System 10 Pro wireless system. System 10 does not use the UHF TV band frequency spectrum (470 - 865 MHz) associated with our other wireless products but operates on the 2.4GHz spectrum, most used for WLAN and Bluetooth® transmission. 2.4GHz offers many benefits, but you must also consider its limitations when using it for wireless audio.

The immediate advantage is that System 10 Pro is completely license free in almost all countries and requires no frequency planning by the installer or operator. However, due to the small wavelength of the 2.4GHz signal (around 12cm), the operating range is shorter than our other wireless systems which use the lower UHF range. This solution is not ideal for open-air scenarios, where long operating distance is required.

However, reduced operating range can also have benefits. For example, if multiple rooms located side-by-side all require a dedicated wireless system, you can reuse the same spectrum by using System 10 Pro in adjacent rooms – very little physical separation between rooms is required.

Another challenge with the 2.4GHz range is the parallel use of Wi-Fi alongside our wireless system. In this case, it is recommended to utilise 5.8GHz for Wi-Fi connectivity in place of 2.4GHz. If this is not possible, the placement of your wireless microphone receiver becomes very important. Here is why System 10 Pro offers the right solution.

2.4GHz antenna cables suffer from higher power losses over their cable run than UHF frequencies. At the same time, many installers do not wish to locate audio racks of receivers in the meeting room, but instead place them in a separate A/V room with the audio mixer and other equipment.

With System 10 Pro, the ATW-RU13 receiver unit can be removed and mounted remotely, connecting to the ATW-RC13 via standard ethernet cable. The ATW-RC13 can stay in the audio rack, whilst the ATW-RU13 can be mounted up to 100m away – on a wall, in the presenter podium, or hidden above the false ceiling in the room. The ATW-RU13 receiver unit is compact in size, and its included wall-mount housing can be painted in any colour to conceal it further.

Ensure to mount ATW-RU13 units as close as possible to the area where the wireless microphones will be used and aim to position any Wi-Fi access points at the opposite side of the room for maximum signal stability.

The compatible Audio-Technica wireless system for this solution is the System 10 Pro.



Product table

Quantity	Code	Description	Alternative
3	ATW-R1320	System 10 Pro Dual Channel Receiver	
6	ATW-T1006	System 10 Boundary Microphone Transmitter	ATW-T1001, ATW-T1002, ATW-T1007
1	ATDM-0604	Digital SmartMixer	

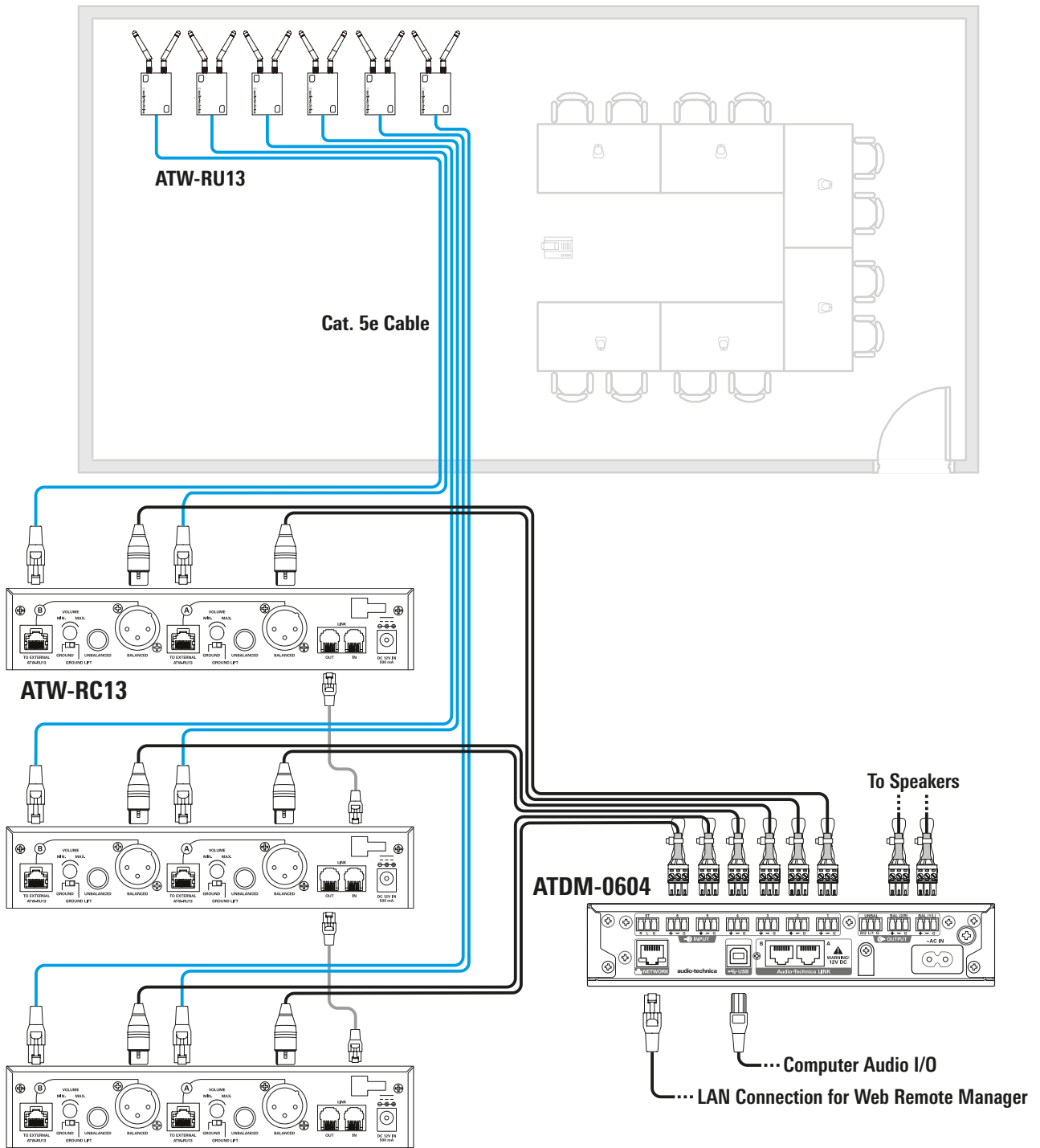

Equipment used

ATDM-0604



3 x ATW-R1320

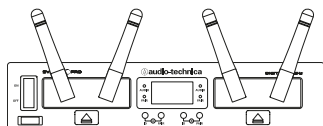

ATW-T1001



6x

ATW-T1002



or

ATW-T1006

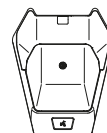

ATW-T1007



or

16-channel wireless system using ATW-DA49a

Where more than four wireless systems are required, this solution may be the answer. Typical applications include larger live bands, music festivals featuring multiple acts, theatre productions, larger conferences, and in sports broadcast where wireless microphones are used to collect sounds of the event.

This solution begins with the 4-channel system from Application 4. In this scenario, up to four of the 4-channel racks are used and then they are linked together using one ATW-DA49a UHF Antenna Distribution System, achieving 16 channels of wireless audio.

Note: pay special attention to the “star” topology wiring of this example: the top ATW-DA49a feeds the antenna inputs of the following four ATW-DA49a. This means that each antenna signal is passing through no more than two antenna distribution units before reaching the receiver.

Also, that the ATW-DA49a’s link output have not been used in this scenario. If only eight channels are required, it is acceptable to use the ATW-DA49a’s link output to pass the signal along to a second ATW-DA49a – the eight receivers then connect via each distributor’s antenna outputs. However, once more wireless systems are needed, it is best practice to implement the star topology given in this example to avoid unnecessary RF signal degradation.

This concept is easily scalable, making it ideal for rental companies, or businesses with flexible technical requirements. Several self-contained modules of four-channel systems can be used and then quickly combined using one additional ATW-DA49a, as and when required.

Refer to the notes in Application. 1 for advice on specifying cable length, active antennas and boosters in the cable run.

This application can be combined with Application 2 and relies on Application 4.

Compatible Audio-Technica wireless systems for this solution include the 2000 Series and 3000 Series.



Product table

Quantity	Code	Description	Alternative
16	ATW-R3210N	Frequency-Agile True Diversity UHF Wireless Receiver	ATW-R3210
16	ATW-T3201	3000 Series Beltpack Transmitter	ATW-T3202 Handheld Transmitter
5	ATW-DA49a	UHF Antenna Distribution System	
1	ATW-A49	Pair of UHF Wide-band Directional LPDA Antennas	ATW-A410P
1	ATW-B80WB	Pair of In-Line RF boosters 470-990MHz	
4	AC25	25/7.6m RG8 Antenna Cable	AC12, AC50, AC100

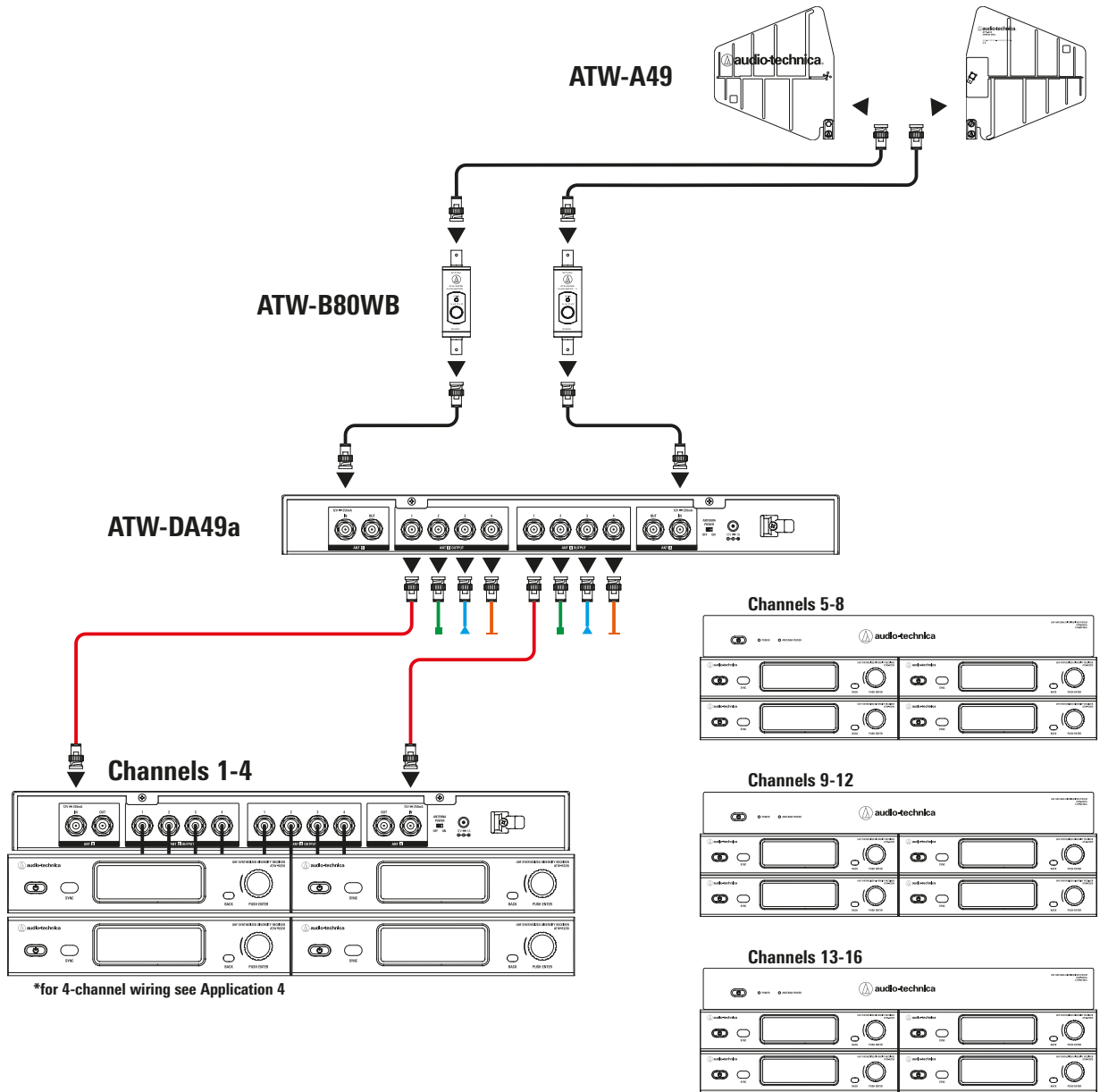

Equipment used

5 x ATW-DA49a



16 x ATW-R3210

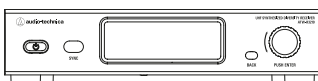

ATW-A49

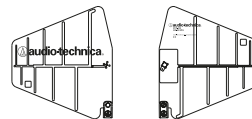

ATW-B80WB

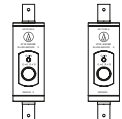

ATW-T3201

16 x

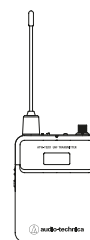

ATW-T3202

or

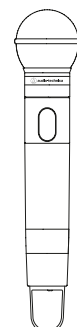

16-channel wireless system using daisy chain

If you require significant UHF flexibility for touring or are simply in need of a reliable wireless system with exceptional audio quality, the 5000 Series is ideal. Here the 5000 Series is used to achieve a 16-way system. This type of setup is commonly found in music festivals, touring rigs, or in smaller installations for theatre, sports and conferencing. This is an alternative option to Application 6, consider both systems to determine which better suits the requirements.

Based around the 5000 Series, the key to this solution is the powerful antenna distribution amplifier built into the ATW-R5220 Dual Receiver. As seen in the diagram, the ATW-A49 antennas connect directly to the receivers without the need to pass through any external distribution units. Each ATW-R5220 then passes the RF signal along to the next receiver in a daisy-chain configuration. With this, up to eight dual-channel receivers can be combined in a simple and efficient way, providing 16 channels of wireless audio.

Pay special attention to the cable run in the diagram. The first antenna signal has been connected to the first receiver, passing down to the eighth receiver; meanwhile, the second antenna signal starts at the eighth receiver and works upwards. This method affords a degree of redundancy, as should any one receiver lose power the remaining units will continue to receive RF signal from at least one antenna.

Refer to the notes in Application 1 for advice on specifying cable length, active antennas and boosters in the cable run.

This Application can be combined with Application 2 and is essential to Application 8.

The compatible Audio-Technica wireless system for this solution is the 5000 Series.



Product table

Quantity	Code	Description	Alternative
8	ATW-R5220DAN	5000 Series Dual Channel Receiver with Dante®	ATW-R5220
16	ATW-T5201	5000 Series Beltpack Transmitter	ATW-T5202 Handheld Transmitter
1	ATW-A49	Pair of UHF Wide-band Directional LPDA Antennas	
1	ATW-B80WB	Pair of In-Line RF boosters 470-990MHz	
4	AC25	25/7.6m RG8 Antenna Cable	AC12, AC50, AC100

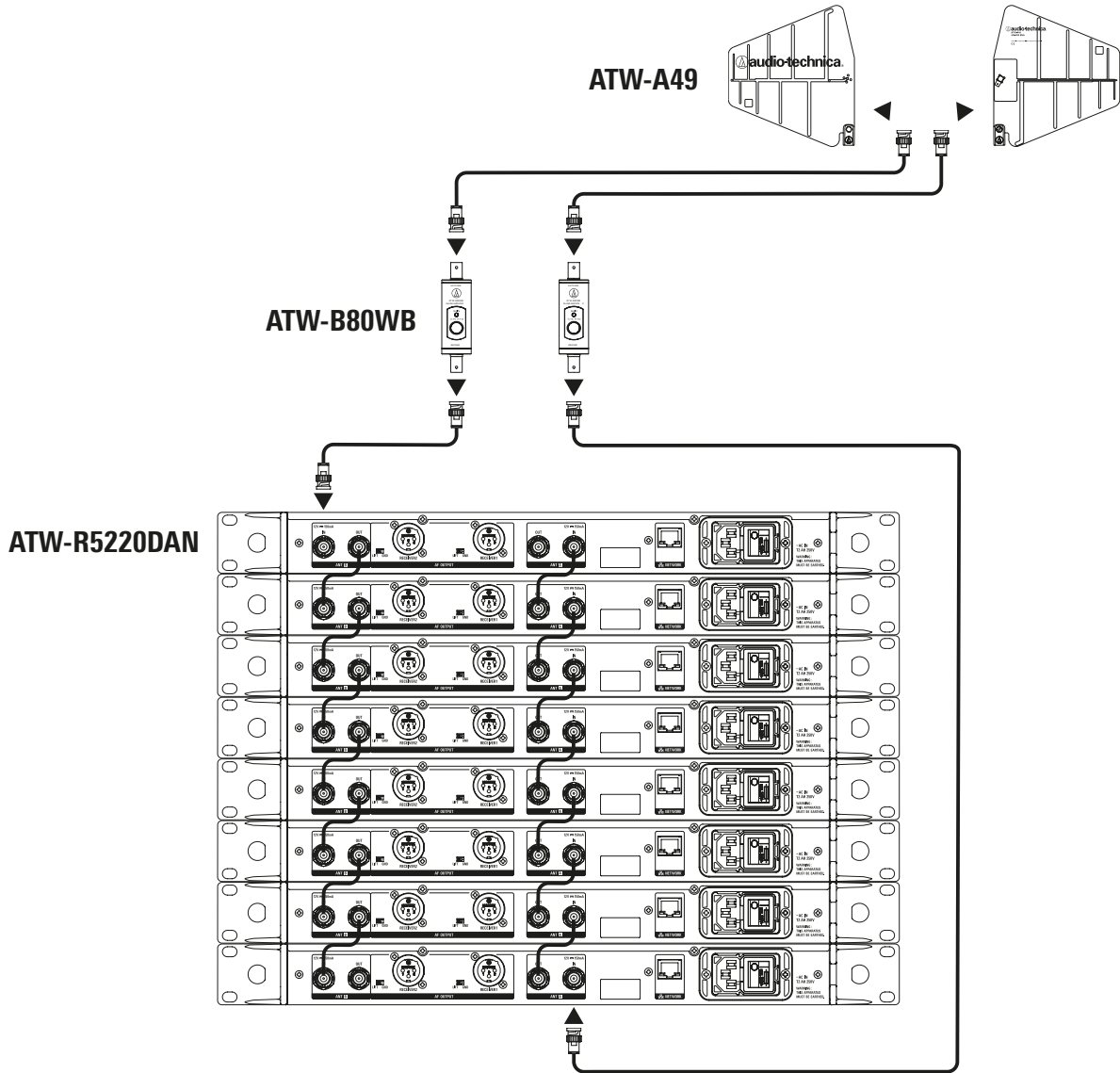

Equipment used

8 x ATW-R5220 / ATW-R5220DAN

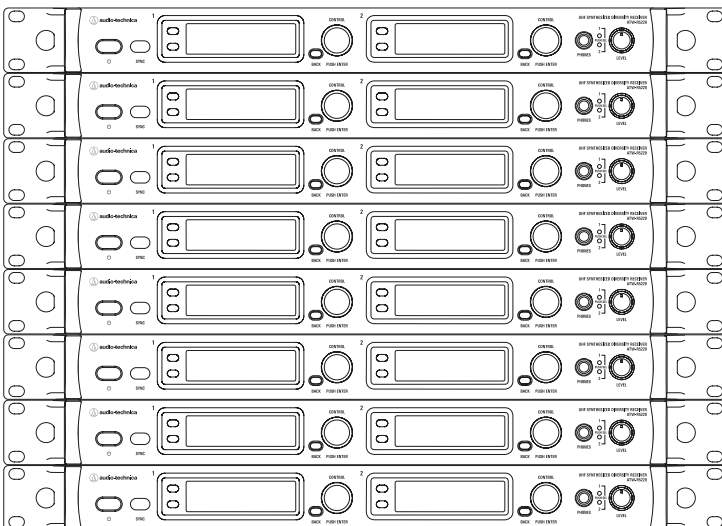

ATW-A49

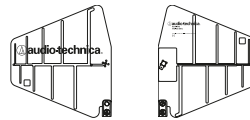

ATW-B80WB

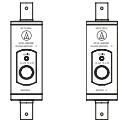

ATW-T5201

16 x

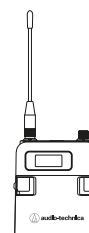

ATW-T5202

or

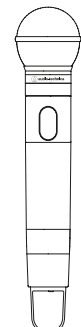

64-channel wireless system / 256-channel wireless system

This system is designed for large scale wireless audio projects, as found in theatre, opera, TV & sports broadcasting, music festivals or any application where high numbers of wireless systems are essential requirements.

This solution begins with the 16-way system shown in Application 7. Having constructed racks of eight dual receivers, one ATW-DA49a UHF Antenna Distribution System can be added. This should be placed after the antennas and linked to up to four of the 16-way racks, allowing for 64 simultaneous wireless audio channels.

Is 64-channels the limit? If more than 64-channels are required, the system can be considered as one "module", and more can be added. Up to four 64-channel modules can then connect to one final ATW-DA49a, opening the possibility for a 256-channel wireless solution – all operating with just one pair of antennas.

Refer to the notes in Application 1 for advice on specifying cable length, active antennas and boosters in the cable run.

This Application can also combine with Application 2 and relies on Application 7.

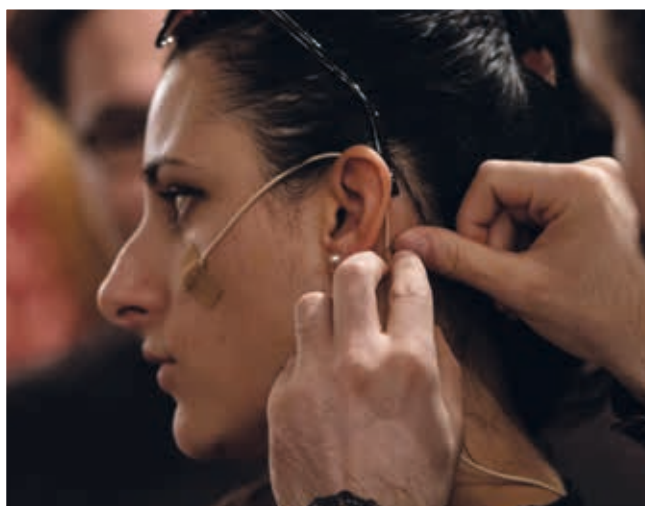

The compatible Audio-Technica wireless system for this solution is the 5000 Series.

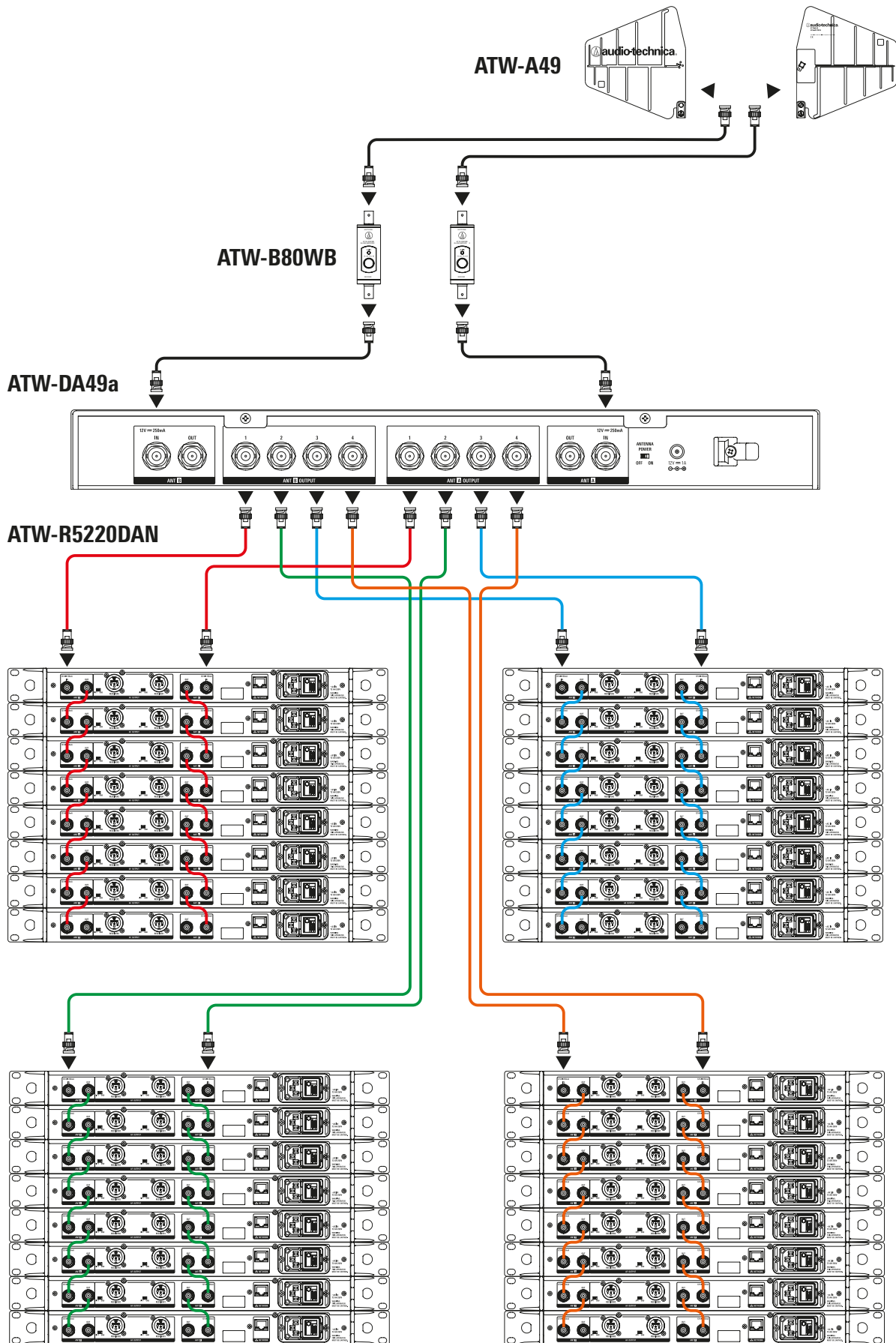

Product table

Quantity	Code	Description	Alternative
32	ATW-R5220DAN	5000 Series Dual Channel Receiver with Dante®	ATW-R5220
64	ATW-T5201	5000 Series Beltpack Transmitter	ATW-T5202 Handheld Transmitter
1	ATW-DA49a	UHF Antenna Distribution System	
1	ATW-A49	Pair of UHF Wide-band Directional LPDA Antennas	
1	ATW-B80WB	Pair of In-Line RF boosters 470-990MHz	
4	AC25	25'/7.6m RG8 Antenna Cable	AC12, AC50, AC100

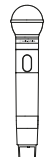

+	<p>OK to use - licensefree, Мож да се използва - Безплатен лиценз, U redu za korištenje - Bez licence, Bez omezení - Bez licence, Ok at bruge - Licens Fri, Sobilik kasutada - litsensivaba, Käyttävissä - Lisenssivapaa, Usage autorisé - Licence libre, Zur Nutzung freigegeben - Lizenzfrei, Επιτρεπτή Χρήση - Χρήση Άνευ άδειας, Használható - Díjmentes, OK a úsáid - ceadúnas saor in aisce, OK utilizzo - Senza licenza, Var izmantot - Licence nav nepieciešama, Leidžiama naudoti - Nelicenzijuojamas, Huwa permess li jintuza - Mhemmx bzonn licenzja, Gebruik toegestaan - Vergunningsvrij, wolno używać - nie wymagana licencja, Ok para usar - Licença livre, Se poate folosi - Nu necesită licență, Bez obmedzenia - Bez licencie, Lahko se uporablja - Brez licence, Ok para usar - Licencia libre, OK att använda - Undantag från tillståndsplikt, lagi ad nota - Má nota án leyfis, Kan benyttes - Lisensfri</p>									
L	<p>License needed, Платен лиценз, Licença potrebna, Nutná licence, Licens påkrævet, Litsents vajalik, Lisenssi tarvitaan, Licence nécessaire, Lizenz- und Anmeldepflichtig, Με Χρήση άδειας, Licenc köteles, Ceadúnas ag teastáil, Licenza necessaria, Licence ir nepieciešama, Licenzijuojamas, Hemm bzonn licenzja, vergunningsplichtig, wymagana licencja, Licença necessária, Necesită licență, Nutná licencia, Licença potrebna, Licencia necesaria, Tillstånd krävs, þarfnast leyfis fyrir notkun, Lisens nødvendig</p>									
in	<p>Indoor only, Само за вътрешно използване, Samo u zatvorenom prostoru, Pouze pro indoor, Kun indendørs, Ainult siseruumides, Vain sisäkäyttöön, Intérieur uniquement, Nur in geschlossenen Räumen, Χρήση ΜΟΝΟ σε Εσωτερικούς Χώρους, Csak beltérben, Dhion ach, Solo uso al chiuso, Tikai iekštelpās, Naudojimi tik patalpoje, Gewwa biss, Alleen in gesloten ruimte, tylko w pomieszczeniach, Samente uso interior, Doar pentru interior, Iba pre indoor, Samo v zaprtem prostoru, Sólo en interiores, Endast inomhus, Aðeins innandyrá notkun, Kun innendørs</p>									
-	<p>Not allowed to use, Не се разрешава използването, Korištenje nije dopušteno, Zakázáno používat, Ikke tilladt at bruge, Ei ole lubatud kasutada, Käyttö ei sallittu, Ne pas utiliser, Nutzung verboten, Μη Επιτρεπτή Χρήση, Tilos használni, Ní cheadaítear a úsáid, Uso non permesso, Nedrīkst izmantot, Neleidžiama naudoti, Mhux permess li jintuza, Gebruik niet toegestaan, nie wolno używać, Não é permitido usar, Nu este permisă folosirea, Zakázané používať, Uporaba ni dovoljena, No se permite el uso, Inte tillåtet att användas, Má ekki nota, Ikke tillatt</p>									
	P1	P1a	P1b	P12	P2	P2a	P2b	P2c	P2d	
	<p>Power limit, Лимит на мощността, Granice snage, Max. výstupní výkon, Sendestyrke maksimalt, Võimsuse limiit, Lähetystehorajoitus, Puissance limitée à, Max. Sendeleistung, Επιτρεπτό Όριο ισχύος μέχρι, Teljesítmény korlát, Teorainn power, Limite di potenza, Jaudas robežvērtība, Galios apribojimas, Sahha limitata sa, Maximaal zendvermogen, limit mocy, Limite de potència, Limita puterii, Max. výstupný výkon, Jakostna omejitev, Potencia limitada a, MAX, Afl takmörkun, Maksimalt tillatt utstrålt effekt</p>									
	10 mW ERP	10 mW ERP	10 mW EIRP	12 mW ERP	20 mW ERP	20 mW ERP	20 mW ERP	20 mW ERP	20 mW EIRP	
	50 mW ERP	50 mW ERP	50 mW EIRP	12 mW ERP	20 mW ERP	50 mW ERP	50 mW EIRP	100 mW ERP	100 mW EIRP	
x1	NO	<p>Vær vennlig å sjekke på http://www.finnsenderen.no/traadlos hvilke frekvenser som kan benyttes i ditt område. Please check on http://www.finnsenderen.no/traadlos which frequencies can be used in your area.</p>								
x2	GR	<p>Εξαιρέση για μεμονωμένη/ανεξάρτητη άδεια χρήσης, και για συσκευές ισχύος εκπομπής μέχρι 10 mW. Εξαιρέση για μεμονωμένη/ανεξάρτητη άδεια χρήσης, και για συσκευές ισχύος εκπομπής μεγαλύτερης απο 10 mW Exemption for individual licensing for devices with power of up to 10mW. Individual licensing required for devices with power over 10mW.</p>								
x3	MT	<p>Jekk joghgbok iccekkja r-regolamenti lokali dwar l-ahhar informazzjoni fuq l-uzu ta' "wireless microphones" Please check local regulations for the latest information about usage of wireless microphones.</p>								

Audio-Technica UK
Audio-Technica Ltd.
Technica House
Unit 5, Millennium Way
Leeds, LS11 5AL
England

T: +44 (0)113 277 1441
F: +44 (0)113 270 4836

E: info@audio-technica.co.uk
eu.audio-technica.com

Audio-Technica Germany
Audio-Technica Deutschland GmbH
Peter-Sander-Str. 43 C
D-55252 Mainz-Kastel
Germany

T: +49 (0) 6134 25734 0
F: +49 (0) 6134 25734 50

E: info@audio-technica.de
www.audio-technica.de

Audio-Technica France
Audio-Technica SAS
130, rue Victor Hugo
92300 Levallois-Perret
France

T: +33 (0) 1 43 72 82 82
F: +33 (0) 1 43 72 60 70

E: info@audio-technica.fr
www.audio-technica.fr

Audio-Technica Spain
Audio-Technica Iberia SAU
Oficina Barcelona: Montserrat Roig 13
08908 L'Hospitalet de Llobregat
Barcelona, Spain
T: +34 935 222 450

Oficina Madrid: Fresadores 35
28939 Arroyomolinos, Madrid, Spain
T: +34 913 619 081

E: info@audio-technica.es
www.audio-technica.es

Audio-Technica Central Europe
Audio-Technica Central Europe Ltd.
H-1107 Budapest
Fogadó u. 3.
Hungary

T: +36 1 433 34 08
F: +36 1 431 90 06

E: info-ce@audio-technica.eu
www.audio-technica.hu

Audio-Technica Benelux
incorporating lemke Roos Audio
Audio-Technica Benelux B.V.
Kuiperbergweg 20
1101 AG Amsterdam
The Netherlands

T: + 31 20 6972121

E: info@audio-technica.nl
www.audio-technica.nl



audio-technica

©2020 Audio-Technica Ltd

E&OE*: Published specifications may be subject to change without notice.
(*Errors and Omissions Excepted)